



GOLF COURSE & DRIVING RANGE EQUIPMENT

2019 - 2020

S I B E
SIBE Golf AG
Altstetterstr. 279
CH-8047 Zürich

 **Duchell**[®]



MAKING THE DIFFERENCE

Over the past years we have become ever more convinced of the need to achieve economies of scale in order to be able to continue to deliver the best possible customer experience.

Through our merger with Piguy Golf Challenge we have achieved what we feel is the right size, a B2B platform to rival any in the business and we have taken a big step into the Proshop business.

We have again drastically increased our stock levels whilst at the same time combining and optimising our product ranges so that we can continue to provide the best possible logistics services from our 6,000 sqm warehouse in The Netherlands and remain the #1 supplier in Europe.

You, as our loyal customers, have made it all possible and we are grateful for this; be assured we will continue to strive to be making the difference and be the ultimate one stop shop in our Industry!

We welcome the opportunity to be of service to you in the near future and, with pride, present you our 2019-2020 catalogue.

Enjoyable reading!

Duco van Oosterhout

A handwritten signature in black ink, appearing to read "D. van Oosterhout", with a long horizontal line underneath it.

Founder and CEO



- CONTENT -

ON THE RANGE

05 - 66

ON THE COURSE

67 - 174

GREENKEEPER EQUIPMENT

175 - 207

IRRIGATION ACCESSORIES

208 - 223

PRO SHOP

224 - 231

TERMS & CONDITIONS AND
PRODUCT INDEX

232 - 237

NOTES

238 - 240

ON THE RANGE

Range Balls	6 - 7
Turf Mats	8 - 11
Mat Frames	12
Classic Range Mat	13
Ball Trays	14
Tee Grass	15
Fiberbuilt Mats	16 - 17
Range Accessories	18
Range Flooring	19
Artificial Turf	20 - 21
Tees	22 - 23
Baskets & Stackers	24 - 25
Bag Stands	26
Range Tape	27
Bay Dividers	28
Launch Monitors	29, 33
Interactive Bay Divider	30 - 31
Simulation & Swing Studio	32
Explanar Training System	34
Targets	35 - 37
Distance Signs	38
Range Banners	39
Interactivity	40
Target Greens	41
Netting	42
Hitting Cages	43
LED Lighting	44 - 45
Ball Pickers & Parts	46 - 49
Manual Ball Collectors	50 - 51
Ball Washers	52 - 54
Ball Transportation Systems	55 - 56
Ball Dispensers	57 - 59
Payment Systems	60 - 63
Bag & Caddy Lockers	64 - 66

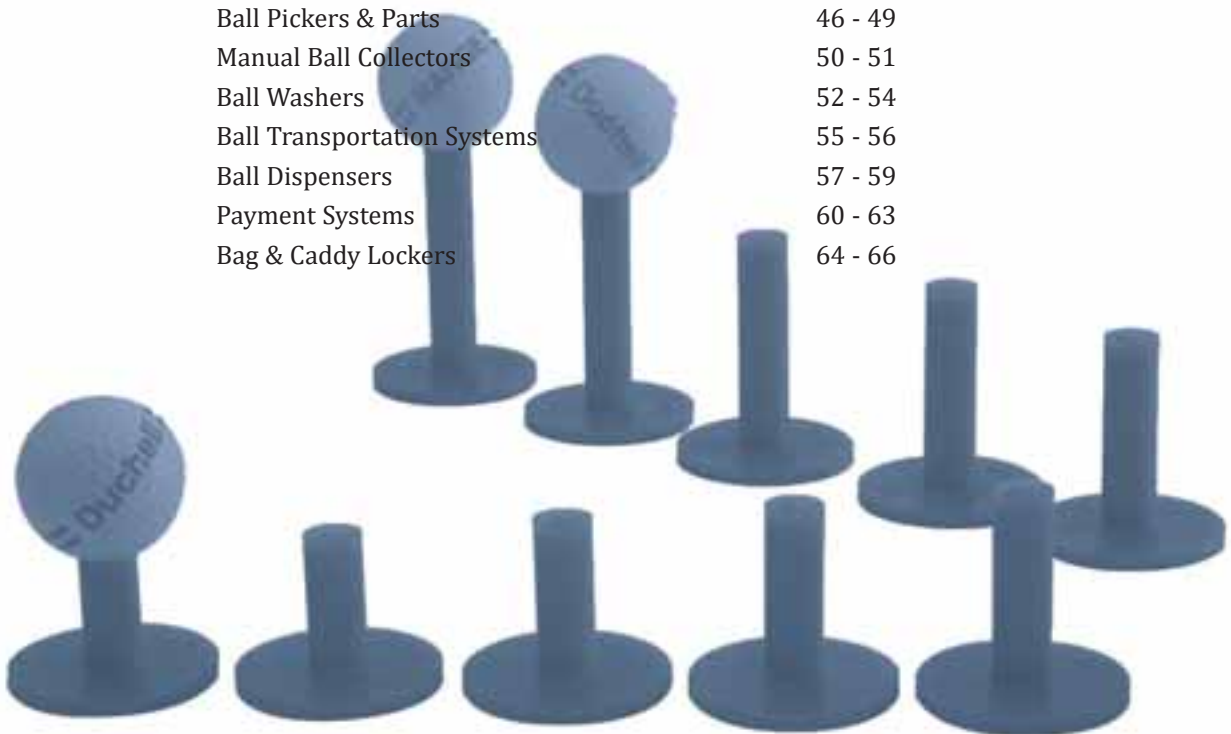

- RANGE BALLS -



Standard: **TW1PWRED**
Logo print: **TW1PWLOG**

1-PIECE DUCHELL RANGE BALL **WHITE**

- Superb quality 1-piece ball, extremely durable.
- Available with standard print or custom logo.
- Colour: white.
- Text: RANGE=RANGE= in red.
- Dimples: 432.
- Compression: 70.
- Packed per 300 balls in a box.
- Price per dzn.



Standard: **TW1PY**
Logo print: **TW1PYLOG**

1-PIECE DUCHELL RANGE BALL **YELLOW**

- Superb quality 1-piece ball, extremely durable.
- Available with standard print or custom logo.
- Colour: yellow.
- Text: RANGE=RANGE= in black.
- Dimples: 432.
- Compression: 70.
- Packed per 300 balls in a box.
- Price per dzn.



Standard: **FG321**
Logo print: **FG321-P**

2-PIECE DUCHELL RANGE BALL **WHITE**

- Market proven highest quality range ball.
- Game ball performance and durability of both print and lacquer.
- Available in standard print or custom logo.
- Colour: white.
- Text: RANGE=RANGE= in red.
- Dimples: 432.
- Compression: 95.
- Packed per 300 balls in a box.
- Price per dzn.



Standard: **FG320**
Logo print: **FG320-P**

2-PIECE DUCHELL RANGE BALL **YELLOW**

- Market proven highest quality range ball.
- Game ball performance and durability of both print and lacquer.
- Available in standard print or custom logo.
- Colour: yellow.
- Text: RANGE=RANGE= in black.
- Dimples: 432.
- Compression: 95.
- Packed per 300 balls in a box.
- Price per dzn.

- RANGE BALLS -

2-PIECE DUCHELL FLOATER **WHITE**

- Durable, high quality, floating range ball.
- Weighs 26 gr. instead of 40 gr.
- Available in standard print or custom logo.
- Colour: white.
- Text: FLOATER=DUCHELL in red.
- Dimples: 432.
- Compression: 80.
- Packed per 300 balls in a box.
- Price per dzn.



Standard: **FG323**
 Logo print: **FG323-P**

2-PIECE DUCHELL SHORT DISTANCE RANGE BALL **WHITE**

- Short distance range ball for reduced flight distance.
- Available in standard print or custom logo.
- Colour: white.
- Text: RANGE=RANGE in green.
- Dimples: 432.
- Compression: 70.
- Packed per 300 balls in a box.
- Price per dzn.



Standard: **FG321MD**
 Logo print: **FG321MD-P**



1-piece logo balls



2-piece logo balls

All balls can be printed, either rotary or on the pole of the ball. All Duchell's golf balls are imprinted during the process of manufacturing, before the finishing layer of lacquer. This enhances the durability of the imprint as opposed to golf balls imprinted after production. Please ask for a quote.

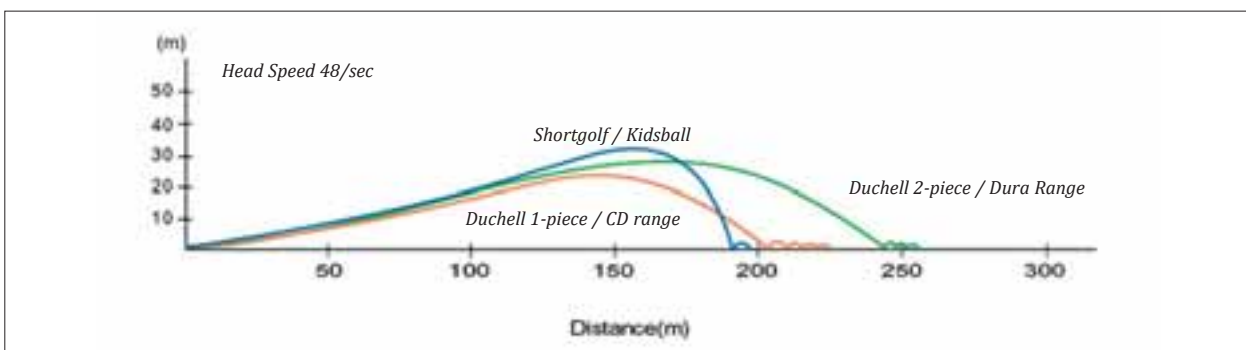

- TURF MATS -

DUCHELL TURFMATS

- Turf made of nylon 6.6 or nylon 6, heat bonded to base for the best durability in the market.
- Super performance.
- All mats comes with 8 holes for tee positioning which enable you to turn the mat.
- Available in two versions: square and octagonal.
- Standard mat size: 150 x 150 cm, other dimensions on request.



Duchell turf mats can be provided with the following types of backings:

GREENTEC PRO

- 3-layer for comfortable play.
- Comes with 15 mm foam and 5 mm hard rubber for stability and anti-slip.
- 15 mm knitted nylon.
- Weight: 27 kg.



Square **DU22598** 150 x 150 cm
Octagonal **DU22590**

All these mats are perfect in combination with either of the IMAX frames of page 12.

GREENTEC LIGHT

- 2-layer for comfortable play.
- Comes with 15 mm foam.
- 15 mm knitted nylon.
- Weight: 15 kg.



Square **DU22602** 150 x 150 cm

- TURF MATS -

AIRFLEX

- Special layer of 10 mm interwoven nylon fibres and a 5 mm foam base for extra shock absorption.
- Comfortable stance and hitting features.
- 15 mm knitted nylon.
- Weight: 17 kg.

Square **DU22519** 150 x 150 cm
Octagonal **DU22531**



QUATTRO EXCELL

- Increased height of 15mm interwoven nylon fibres.
- Ultimate shock absorption and functionality.
- 15 mm knitted nylon.
- 2 mm non-woven cloth base for stability and anti-slip.
- Weight: 16 kg.

Square **DU22516** 150 x 150 cm



The picture shown below shows the differences between the Airflex and the Quattro Excell

The Airflex (left) comes with 10 mm interwoven fibers and a 5 mm foam base.

The Quattro Excell (right) comes with 15 mm interwoven fibres and a non-woven cloth base.



- TURF MATS -

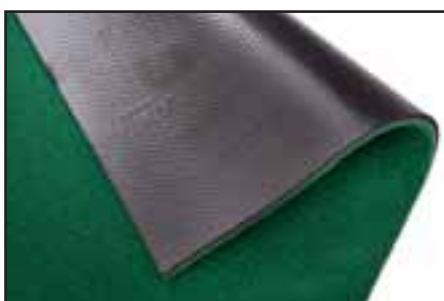

GREENTEC SMARTLINE MAT

- Flexible and comfortable.
- Nylon pile heat bonded with PU glue for extra strong adhesion.
- 15 mm NBR foam base for great shock absorption.
- Extremely durable.
- 5 year Non-curl guarantee.
- Playing mat size 150 x 150 cm.
- Comes with 8 tee holes.
- Weight: 16 kg.

Greentec Smartline	DU22605
Greentec Smartline Flower	DU226053
Greentec Smartline Cloud	DU226054
Greentec Smartline Custom shape	DU226052

Standard size: 150 x 150 cm



The Flower



The Cloud



The Smartline mats can also be ordered in fun shapes and sizes to jazz up the driving range and make it more appealing to the younger generation. Think about combining these shapes with youth practice aids.

MULTILEVEL PRACTICE MAT

- Practice the awkward lies on this Multilevel practice tool.
- Extra service for your golfers.
- Made of light reinforced composite material for easy turning and maximum durability.
- Soft feel extra-long turf will hold the golf ball in any lie.
- Mat size: ø 140 cm.
- Weight: 27 kg.

MX221201



- TURF MATS -

TEACHING MAT

- One of the finest teaching aids in the Industry!
- Sewn-in teaching lines of coloured grass.
- Turf made of nylon 6 for comfortable play.
- Now comes with the Quattro Excell base.
- Ultimate shock absorption and functionality.
- 15 mm knitted nylon.
- Four tee-holes.
- Mat size: 150 x 150 cm.
- Weight: 22 kg.

DU22597

NEW improved backing!



*Increased height of 15 mm interwoven nylon fibres.
With 2 mm non-woven cloth base underneath for stability and anti-slip.*

TEE TURF - THE ALL IN ONE SOLUTION

- 40 mm pile non infill giving a firm stance.
- Possibility to use regular tees.
- Easy to install.
- All year round perfect tee solution or winter tee.
- Comes either in a 150 x 150 cm mat with foam and rubber base or on a roll with latex backing.
- Roll width: standard 2 mtr. 4 mtr available on request.
- Roll length: max 18 mtr.

Tee Turf 150 x 150 cm mat
Price per m² on roll

DU22540
DU22542



Tee Turf 150 x 150 cm mat



*Tee Turf 150 x 150 cm mat
with foam and rubber base.*



*Tee Turf on roll: width 2 mtr. (4 mtr on request)
On a roll with latex backing.*

- MAT FRAMES -



IMAX CLASSIC AIRLASTIC FRAME

- 20 mm rubber granulate airlastic base has a combination of air and elasticity for improved shock absorption for comfortable play.
- Combine the looks of the Classic with the economical features of the reusable frame.
- Will hold any 150 x 150 cm range mat (mat not included).
- Outer size 170 x 170 cm.
- Weight: 50 kg.

Classic Airlastic Frame

MX221204



The thick granulate base with air chambers combined with the base of the range mat gives the player maximum shock absorption.

IMAX MATKEEPER

The Matkeeper offers the perfect inexpensive way to finish your driving range mat.

- Made from highly durable rubber.
- Drainage holes in the base to prevent the mat sitting in water.
- Prevents lighter-weight mats from moving in the bay.
- Will hold any 150 x 150 cm range mat (not included).
- Outer size: 156 x 156 cm.
- Weight: 27 kg.

Imax Matkeeper

MX221300



Perfect combination with any of the Duchell turf mats.



Predrilled holes for maximum water drainage.

- CLASSIC RANGE MAT -



IMAX CLASSIC RANGE MAT - THE ORIGINAL

- Our #1 Best Selling mat!
- The 20 mm rubber granulate airlastic backing has a combination of air and elasticity for improved energy and shock absorption for comfortable play.
- The turf is heatbonded to the base- therefore preventing separation.
- Bottom layer designed to decrease slide and increase stability.
- Top layer manufactured with woven nylon for long life and unequalled comfort.
- Comes with 8 tee holes.
- Playing mat size 150 x 150 cm.
- Outer size: 170 x 170 cm.
- Weight: 55 kg.

Imax Classic

MX221200



Turf heatbonded to the base.

- TRAYS -



RECYCLED RUBBER BALL TRAY

- Made of recycled rubber.
- Holds approx. 100 balls.
- Size: 63 x 33 cm.

RSRAM0010



RUBBER BALL WING

- Made of durable, vulcanized natural UV-resistant rubber.
- Holds approx. 150 balls.
- Size: 107 x 29 cm.

MX221405



- TEE GRASS -

TEE TURF - THE ALL IN ONE SOLUTION

- 40 mm pile non infill giving a firm stance.
- Possibility to use regular tees.
- Easy to install.
- All year round perfect tee solution or winter tee.
- Comes either in a 150 x 150 cm mat with foam and rubber base or on a roll with latex backing.
- Roll width: standard 2 mtr, 4 mtr available on request.
- Roll length: max 18 mtr.



Tee Turf on roll

Tee Turf 150 x 150 cm mat

DU22540

Price per m² on roll

DU22542



*Tee Turf 150x150 cm mat
with foam and rubber base.*



*Tee Turf on roll: width 2 mtr (4 mtr on request)
with latex backing.*

TEE GRASS 30

- All year round tee solution, playable in any weather condition.
- Full 3 cm nylon pile, monofilament curled yarn for stable stance.
- Roll width: 4 mtr.
- Roll length: max 25 mtr.



Teegrass 30

Price per m² on roll

DU22501



- FIBERBUILT MATS -



See page 22, 23 for tees and page 14 for ball trays.

FIBERBUILT GOLF MAT SYSTEMS

- Combination of natural aesthetics and durability.
- The most comfortable inserts fitted in a rubber mat frame.
- Easy changing and replacing.
- Optional tees and ball wing.



The panel "component system" allows for rotation and inexpensive replacement.



Rubber ball wing holds up to 100 balls.



Artificial grass nylon 6.6 stance mat for convenient and extra durability.

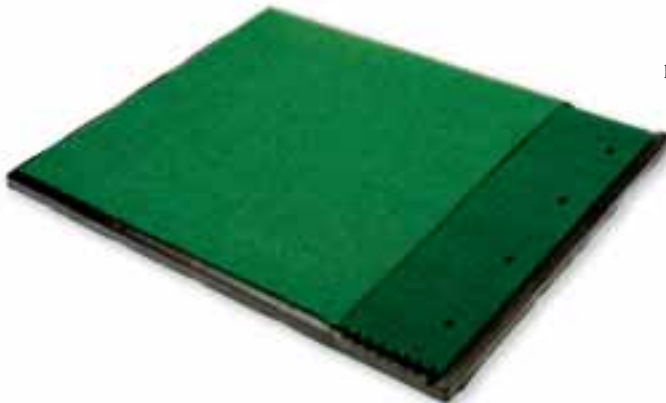

FIBERBUILT SINGLE INSERT MAT SYSTEM COMPLETE

- Including:
 - Rubber single frame.
 - Duchell grass stance mat.
 - One Fiberbuilt 4-panel insert.
- Size: 150 x 120 cm.
- Weight: 32 kg.

Single system

FIS4R

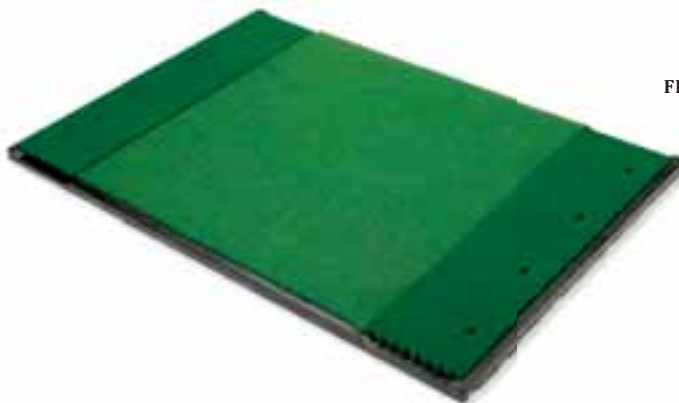

FIBERBUILT DOUBLE INSERT MAT SYSTEM COMPLETE

- Including:
 - Rubber double frame.
 - Duchell grass stance mat.
 - Two Fiberbuilt 4-panel inserts.
- Size: 180 x 120 cm.
- Weight: 36 kg.

Double system

FIS24R

- FIBERBUILT MATS -



PARTS AVAILABLE SEPERATELY:

FIBERBUILT SINGLE RUBBER FRAME ONLY

Size: 150 x 120 cm **FIS4R-F**

FIBERBUILT DOUBLE RUBBER FRAME ONLY

Size: 180 x 120 cm **FIS24R-F**

DUCHELL NYLON 6.6 GRASS STANCE MAT ONLY

Size: 118 x 118 cm **MX221402**

LOGO STANCE MATS AVAILABLE, PLEASE ASK FOR A QUOTATION.



FIBERBUILT RUBBER BALL WING

Size: 107 x 30 cm **FI555**



VARIOUS 118 X 30 CM INSERTS TO FIT FIBERBUILT FRAME:

FIBERBUILT 4-PANEL INSERT

- 4-Panel insert 118 x 30 with 30 mm straight nylon fibres.
- Maximum shock absorption due to the extra high pile.
- Individual panels can be replaced or rotated.

FI305/40-4



IMAX ULTIMA INSERT

- Imax Ultima insert 118 x 30 cm with extended 30 mm foam base.
- Maximum shock absorption due to extra thick base.

MX221404



TEE TURF INSERT

- Tee Turf insert 118 x 30 cm with full 40 mm turf.
- Will hold regular wooden tees.
- Complete with foam base and hard rubber backing for maximum stability.

DU22545

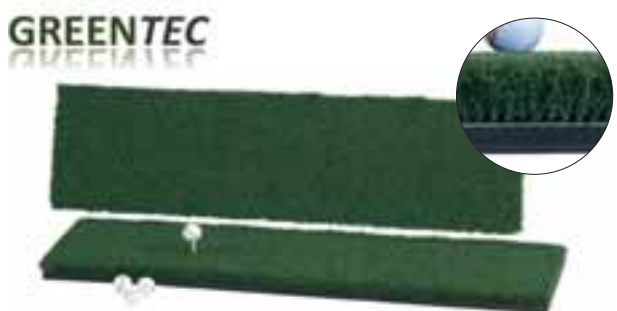

- RANGE ACCESSORIES -



IMAX IMPACT PROOF GOLF MIRROR

- No wear and tear.
- Impact proof construction will take beating from clubs and balls.
- Impact proof glass for perfect reflection.
- Easily wall mounted with the 2 frame hooks.
- Size: 80 x 200 cm.

DU42230



RANGE FLOORING

- Create a cosy ambiance on your driving range and people will enjoy practicing even more!
- There are various ways of covering the floor on the range – from sand filled artificial turf to walking grass and rubber tiles.
- Create different areas on the range by using different colours and stripes.
- Most turf options can be used both indoor and outdoor.
- Please ask for a custom quote for installation.



- RANGE FLOORING -

WALKING GRASS

- Combination of dark green and lime green.
- Pile height 15 mm for comfortable walk.
- Roll size 4,57 x 25 mtr.
- Coating: PU.
- Please ask for an installation quote for your specific project.

Walking Grass price per m² on roll **DU42216**
 Grass installation **DU42215**



RANGE GRASS

- Available in 4 colours: Olive, Verde, Blue and White.
- Filled with round-shaped, dried silica sand.
- Can also be used for target greens, filled with sand (not included) for increased shock absorbency.
- Roll size: 4 x 25 mtr.
- Please ask for an installation quote for your specific project.

Range Grass Olive **DU42201**
 Range Grass Blue **DU42202**
 Range Grass Verde **DU42203**
 Range Grass White **DU42204**
 Grass installation **DU42215**



Olive (greens)



Verde (fairways)



Blue (water hazards)

RUBBER SQUARE SAFETY TILES

- Made of compressed rubber granulate.
- Available in red and green.
- Available in 30 and 40 mm thickness.
- Tile size: 100 x 100 cm.
- Weight: 26 kg.

Per m ²	30 mm	Red	DU29681
		Green	DU29682
	40 mm	Red	DU29683
		Green	DU29684



- ARTIFICIAL TURF -

ARTIFICIAL TURF

Duchell offers a full range of artificial turf. From turf tee lines to greens and range grass – Duchell offers ‘on site’ advise and custom quotes. Do ask our experts for a visit. Shown on this page are some examples of the projects Duchell has realized over the last few years.

Artificial tee lines and artificial turf tee boxes give you an all year round perfect tee solution. No watering or divots and playable in any weather condition. Duchell’s tee turf has a great resemblance with natural turf and offers the players the possibility to tee-up using their own wooden tees.

Target greens will make your range more attractive for practice – nicely visible target greens are available in any size and either single or multiple coloured. In combination with our highly durable range grass you will create a cosy ambiance on the driving range and people will enjoy practicing even more.



Tee line



Artificial turf tee box



Target green



Range grass & target greens

- ARTIFICIAL TURF -



Photo: AM59 Golf Academy, Orlando FL, USA

INDOOR GRASS

Duchell offers a whole range of products for both indoor and outdoor facilities - including the artificial grass for putting greens, fairway simulation, wooden benches, hitting cages and netting.

As there is such a large variety of different materials used as well as different circumstances and demands in each location, Duchell offers 'on site' advice and custom quotes. Do ask our experts for a visit.

Duchell also offers a full Turn Key Simulation Package (see page 36 & 37 Launch Monitors).



Greentec Putting Turf comes on
4 x 25 mtr rolls

GREENTEC PUTTING TURF

- Comes in field green colour.
- Non-infill product.
- Can be used both indoor and outdoor.
- Roll size: 4 x 25 mtr.
- Coating: PU.
- Quotes including installation on project base.
- Standard turf average Stimp 10.

Greentec putting turf price per m² on roll **MX2212021**



- TEES -

SOKO TEES

- High quality natural rubber from SOKO.
- Packed per 50.

35 mm	SKGL069
40 mm	SKGL071
45 mm	SKGL068
50 mm	SKGL078
55 mm	SKGL098
60 mm	SKGL058
65 mm	SKGL059
70 mm	SKGL099
75 mm	SKGL100
80 mm	SKGL101



HOLLOW TEE

- Tees made of PE for extra durability.
- Available in 3 different sizes.
- Packed per 50.

57 mm hollow tee	DU29302
67 mm hollow tee	DU29303
73 mm hollow tee	DU29304



PRESS TEE

- Replaces self-install rubber tees and lifting of mats on range.
- User cuts the tee down to own desired height.
- Tees mostly sold through the Pro shop.
- Packed per 50.

Press tee	DU29320
-----------	----------------



- T E E S -

SOKO CROSS TEE

- Superb quality natural rubber from SOKO.
- Holds a standard wooden or plastic tee.
- To fit all standard turf mats.
- Enables users to set their own tee height.
- Packed per 50.

Cross tee 25 mm

P139E



FRICTION FIT TEE

- Tees made of PE for extra durability.
- To fit high pile or thick base mats or inserts.
- Available in 2 sizes: 30 and 50 mm.
- Packed per 50.

Friction fit tee holder 30 mm

DU226076

Friction fit tee holder 50 mm

DU226072



ADJUSTABLE STEPLESS TEE

- Extremely flexible.
- Can be adjusted to various heights to suit the driving range mat or club.
- No need to change tees.
- Provides perfect ball support.
- Extremely durable as the tee shaft cannot be pulled out from the base.
- Two sizes available: regular 57 – 81 mm & XL 68 – 95 mm.
- Packed per 50.

Adjustable stepless tee regular

DU22615

Adjustable stepless tee XL

DU22616



- BASKETS -



IMAX SQUARE PLASTIC BASKET

- Made of strong plastic, offering great stability.
- Flat edges – no more baskets rolling around the driving range.
- Hangs properly on ball dispenser.
- Possibility for advertisement.
- Packed per 10.
- Available in black or green and two sizes.

Capacity 75 balls

Green **MX29520**
Black **MX29521**

Capacity 120 balls

Green **MX29530**
Black **MX29531**



OPTIONAL CUSTOM STICKER FOR SQUARE BASKET

- The rectangle on 2 sides of each basket offer space for an advertising sticker.

Sticker for basket 75 balls **MX29522**

Size: 90 x 65 mm

Sticker for basket 120 balls **MX29532**

Size: 95 x 70 mm



WIRE BASKET ROUND

- Made of chromed wire.
- Stackable.
- Available in 2 sizes.
- Packed per 10 pieces.

Capacity 50 balls **MX29250**

Capacity 75 balls **MX29275**



IMAX PLASTIC BASKET

- Plastic, no rust and no dents.
- Solid, available in 3 sizes.
- Packed per 10 pieces.
- Colour: Green

Capacity 50 balls **MX29450**

Capacity 75 balls **MX29475**

Capacity 150 balls **MX29510**

- BASKETS & STACKERS -

TEAK WOODEN BASKET

- Made of durable teak featuring powder-coated band and wire handle for added life.
- Capacity 90 balls.

Wooden basket

PA10725



PYRAMID BALL STACKER

- Green metal ball stacker.
- Trays made of black plastic for the 55 capacity and of metal for 140 capacity stacker.
- Available in 2 sizes: 55 or 140 ball capacity.

BALL STACKER

To hold 55 balls

DU49570

To hold 140 balls

DU49571

PLASTIC BALL TRAY FOR BALL STACKER

- Packed per 10 pieces.

To hold 55 balls

DU49565

METAL BALL TRAY FOR BALL STACKER

- Packed per 10 pieces.

To hold 140 balls

DU49567



BASKET STAND

- Easy and clean storage.

• Size: 50 x 45 x 45 cm

RS109950



- BAG STANDS -



BAG STAND TEAK

- Made from teak wood.
- Foldable for easy removal.
- Size: 40 x 46 x 80 cm.

DU82332



STEEL BAG STAND

- Ideal addition to any tee-line.
- Sturdy coated steel stand, tube Ø 32 mm.
- Colour: green.
- Size: 40 x 40 x 80 cm.

P77151



TECHNOWOOD BAG STAND WITH CUP HOLDER

- Bag stand with cupholder.
- Made from Technowood.
- Available colours: brown and green.
- Foldable for easy removal.
- Size: 57 x 52 x 75 cm.

Bag stand with cup holder brown **P78710**

Bag stand with cup holder green **P78711**

Bag stand with cup holder white **P78712**



RECYCLED PLASTIC FOLDING BAG STAND WITH OR WITHOUT CUP HOLDER

- Manufactured with sturdy, low-maintenance recycled plastic.
- Colours: black, brown and green.
- Folds for stacking or storage.
- Size: 53 x 50 x 68 cm.

Bag stand with cupholder black **MT692210**

Bag stand with cupholder brown **MT692212**

Bag stand with cupholder green **MT692214**



Bag stand without cupholder black **MT692200**

Bag stand without cupholder brown **MT692202**

Bag stand without cupholder green **MT692204**

- RANGE TAPE -

DESIGNED TO REPLACE TEE LINE ROPES



Offer your range sponsor great visibility by having their logo repeated all the way across the length of the driving range or custom print your club logo showing eye for detail.

Range Tape is made of similar material as seat belts and is extremely strong. It can be re-used and is 100% washable giving you multiple years of stylish appearance.

SELECT YOUR LENGTH

- Standard length: 22,5 mtr.
- 22,5 mtr rolls require 4 ground stakes.
- Custom lengths available upon request.

CUSTOMIZE YOUR LOOK

- Pattern - Colour - Tagline
- Graphics - Logo - Slogan

Range tape 22,5 mtr	DU29403
Roller	DU29401
Ground stakes	DU29402



- BAY DIVIDERS -



PATISSON TEAKWOOD BAY DIVIDER

- Made from teak wood.
- For the classic look on your driving range.
- Stabilizing feet made from stainless steel.
- Size: 120 x 68 cm.

Teak bay divider

DU82333



TECHNOWOOD BAY DIVIDER

- Made from Technowood.
- Elegant bay divider for grass tees.
- Size: 125 x 14 x 6 cm.

Bay divider Technowood brown **P78810**

Bay divider Technowood green **P78811**

Bay divider Technowood white **P78812**

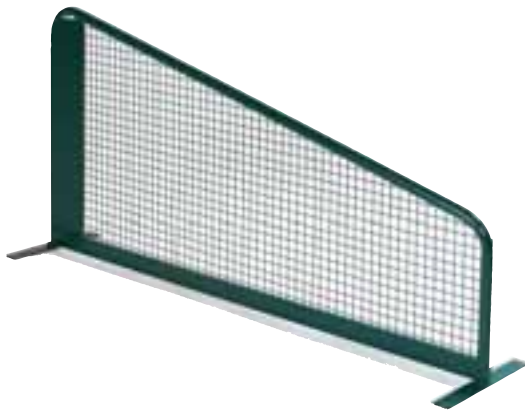

STEEL BAY DIVIDER

- Made from zinc-plated and powder-coated steel.
- Colour: green.
- Size: 152 x 76 x 4 cm.

Steel bay divider

P77680



PROMOTIONAL BAY DIVIDER

- Made from zinc-plated and powder-coated steel.
- Comes with plain green canvas banner.
- Colour: green.
- Size: 152 x 76 x 4 cm.

Promotional bay divider

P77681

CUSTOM BANNER FOR PROMOTIONAL BAY DIVIDER

Single sided printed

P77682

Double sided printed

P77683

- LAUNCH MONITORS -

ES12 PLAYER

The ES12 portable launch monitor is an extremely accurate portable launch monitor that offers ball speed & distance data with minimal set-up. Paired with the free Ernest Sports app, the ES12 Player provides the ability to track and analyze your practice sessions. Using Doppler radar the unit displays the ball speed and distance of each shot instantly on an LCD screen and app. Designed with convenience in mind, the ES12 Player easily fits in your golf bag and is encased in a durable rubber boot. From junior golfers to scratch golfers, this system brings new life to your practice sessions by providing the data needed to analyze, track and improve your game.

Free ES12 App Features:

- Bluetooth connection.
- Visible and audible feedback.
- Track and store range sessions.
- E-mail data in Excel format.
- Course caddy.
- Club gapping.
- Side-by-side video analysis.
- Skills challenge.

Benefits:

- Doppler radar technology.
- 2 data points.
- Accurate.
- Portable.
- Minimal set-up.

ES12 Player **ES0012**



ES14 PRO

Practice Like a Pro.

Ernest Sports has revolutionized the game with a tool for teaching professionals, club fitters, and serious golfers. The ES14 Pro launch monitor delivers critical data instantly & affordably. The unit offers a wide range of statistical information including club speed, launch angle, ball speed, smash factor, spin rate & distance. When combined with the free ES14 App, users have the ability to dig even deeper into their shot analysis with features such as audible feedback, club averages, and a skills challenge. Enhance your learning, teaching or club-fitting experience with the ES14 Pro from Ernest Sports.

Free ES14 App Features:

- Bluetooth connection.
- Visible and audible feedback.
- Track and store range sessions.
- E-mail data in Excel format.
- Skills challenge.
- Course view.

Benefits:

- 2 Doppler radars.
- 7 data points.
- Accurate.
- Affordable.
- Minimal set-up.
- Portable.

ES14 Pro **ES0014**



- INTERACTIVE BAY DIVIDER -



ES15 WITH CUSTOMISED PANELS

ES15 Range owners have the opportunity to customize the product's panels. Each club or facility can have their own logo or sponsor printed on both sides of the unit; with panels 75 cm wide and 38 cm high, your design is large enough to generate interest from a distance. Duchell's in-house graphics team will work with you to create the atmosphere and image you imagine for your facility. Add to your club's prestige by branding the range with your custom-designed ES15 Range panels.

Customised panel for ES15 **ES0015C**

ES15 ACCESSORIES

Waterproof cover **ES0015WPC**

Battery Pack **ES0015BP**

We suggest every 5 units you purchase at least one additional battery pack.

Charger **ES0015CH**

Unit itself comes with a rechargeable battery but not the charger. One charger suggested per 5 units.

Remote control **ES0015RC**

Suggested for Driving Ranges to be able to control the usage. Unit can be turned on and off with the remote control device.

Increase Revenues

Increase your golf club's revenue with the ES15 Range. Advertising space on custom ES15 Range panels can be rented by local advertisers which produce a monthly revenue stream. Duchell also offers an optional remote control key fob allowing club managers to turn the ES15 Range on and off from the office. This allows clubs to charge for use of the ES15 Range.



- INTERACTIVE BAY DIVIDER -



ES15 RANGE

Enhance the driving range experience with the latest innovative technology.

The ES15 is an interactive bay divider using Doppler radar technology. It provides ball speed, club speed, smash factor, distance, launch angle and spin rate in the convenient form of a sleek bay divider. For more in-depth statistics, users can easily pair the unit to their smart device with the free Ernest Sports app. With customizable graphics, the ES15 Range is sure to modernize your driving range or golf lessons.

Free ES15 App Features:

- Bluetooth connection.
- Visible and audible feedback.
- Track and store range sessions.
- E-mail data in Excel format.
- Skills challenge.
- Course view.

Benefits:

- 3 Doppler radars.
- 7 data points.
- Easy-to-use.
- Potential revenue stream.
- Rugged.
- Water resistant.
- Accurate.
- 140 hour battery life.

ES15 Range

ES0015

FREE APP FOR ES15 RANGE

Shot data is displayed instantly on 2 LCD displays, but the ES15 Range is also equipped with Bluetooth technology allowing each user to connect to the free Ernest Sports App. Syncing a smart phone or tablet to the ES15 Range is quick, easy and opens a variety of additional features. Users have the ability to hear their shot data audibly, save and email their range session, view averages by club and much more. Once the app is on a customer's phone, it also serves as a regular reminder of the facility where they use the device.

Dual LCD Displays and the Ernest Sports Free App.



FREE App:

View each range session, compare and analyze your swing.

- SIMULATION & SWING STUDIO -



ES20/20 IN SIMULATOR OR SWING STUDIO

In addition to the Ernest Sports app, the ES20/20 is compatible with full golf simulation from The Golf Club, E6 and Perfect Parallel. With 3 great simulation options and well over 100,000 courses to play (including some of the most famous in the world!) the ES16 will always provide the next challenge to keep you and your golf game improving. Increase the length of your golf season by playing an 18-hole course from the comfort of your own home any time of the year.

Also available from Duchell - The Turn Key Simulation Package.

Receive all you need to have full simulation at your home, golf facility or business.



The Duchell Turn Key Simulation Package Includes:

- ES20/20 Tour Launch Monitor.
- Premium Impact/Theatre Screen.
- Simulation Bay Enclosure.
- Magstrike Dual side mat.
- Simulation-Specific Laptop Computer.
- HD Projector with Ceiling Mount.
- 30 Day Full Simulation Demo.
- All necessary cords.



- LAUNCH MONITOR -

ES20/20
Perfect Vision



ENHANCED DOPPLER TECHNOLOGY - STATE OF THE ART HIGH SPEED CAMERAS - FULLY FUNCTIONAL INDOOR / OUTDOOR
DIRECTLY MEASURED CLUB / BALL DATA - ON-BOARD LCD DISPLAY

ES20/20 PERFECT VISION - APP



WHAT DOES THE ES20/20 CALCULATE?

Ball Data, Carry Distance, Total Distance, Roll Distance, Ball Speed, Lateral Carry Distance, Lateral Total Distance, Launch Angle, Launch Direction Angle, Spin Rate, Spin Axis, Maximum Height, Hang Time, Shot Dispersion, Landing Angle, Club Data
Club Head Speed, Smash Factor, Angle of Attack, Spin Loft, Face Angle, Club Path, Dynamic Loft

Also available: Full simulation & Game play with putting.

ES20/20 Range

ES0020

- EXPLANAR TRAINING SYSTEM -



Helps new golfers improve swing technique and cut their learning curve

The Explanar was created to help people learn how to play golf. Learning to play golf can be likened to learning how to ride a bike, and this concept is the basis for the Explanar's teaching methods.

If you think back to when you were a child, you learnt how to ride a bicycle with training wheels, as this helped you to learn how to balance. Even when the training wheels are removed, no one is able to ride a bicycle in a completely perfect upright position, but instead sway in and out of balance.

This is the same when playing golf and trying to swing along your optimum swing plane. No golfer can always swing along their optimum swing plane, but the Explanar helps you feel the perfect golf swing, and this movement is memorized in your muscles to be re-enacted on the golf course.

Just like when you remove the training wheels and you can ride a bike, when you leave the Explanar your muscles have memorized the swing movement to aid you in hitting the perfect shot on the course.

Teaches more experienced golfers advanced swing techniques

If you are a more able golfer, the Explanar can be used to help with a variety of specialized shots, to curing a hook or a slice, or by teaching you how to hit draw and fade shots intentionally, the golf swing aid will be able to refine your complete golfing game.

Explanar Components

The Explanar golf swing aid comes complete with the hoop, the plane fin, and the (long) power roller.

The Explanar is adjustable, and can therefore be used by golfers of all heights and for a variety of golf swings depending on the club you intend to use.

Inventor

The Explanar golf training aid was invented by PGA Master Professional Luther Blacklock, and it is the result of his PGA teaching practice for over thirty years. It has several unique features and has patents in the US and the rest of the world.

THE EXPLANAR

Explanar Home complete (including 1 long roller) **EXP10010**

Explanar Junior complete (including 1 junior roller) **EXP10020**

SPARE PARTS:

Long Roller **EXP10030**

Short Roller **EXP10031**

Junior Roller **EXP10032**



Long and short roller compared to golf clubs.

- TARGETS -

SONIC TARGET

- For medium distance practice.
- Wheels for flexibility, can be moved to preferred distance or when mowing.
- Makes a noise when the target is hit.
- Standard target comes with "Hit me" sticker, as shown.
- Optional promotional sticker, price on request.
- Size Ø 100 cm.

Sonic target **DU24210**
 Custom sticker **DU24211**



TEE TARGET

- Easy to assemble, easy to move.
- Sturdy Polyethylene frame.
- Weighted base for extra stability.
- Yellow accent pads can be added for extra visual impact.
- Size Ø 122 cm.

Tee target **DU24250**
 Set of 6 yellow pads **DU24251**



THE GOLF TARGET

- The perfect aiming point to improve accuracy!
- High Impact shock resistant TPO plastic target.
- 3 different angles to use; flat, 40 and 45 degrees.
- Fully water resistant with a waterproof frame.
- 2 integrated frame ground spikes for windy conditions.
- Easy exchangeable graphics sign to promote any function.
- Order graphics sign separately.
- Size Ø 120 cm, logo size Ø 80 cm.

The Golf Target - Frame only **DU24220**

ORDER SEPERATELY:

Standard Graphics sign **DU24221**
 Custom Graphics sign **DU24222**



- TARGETS -



ADJUSTABLE BULLS EYE TARGET PRO XL

- Tubular 5 cm diameter steel powder coated frame.
- Adjustable angle to enable different use.
- Large 220 cm diameter aiming circle.
- Comes with netting or custom banner.

Adjustable Bulls eye Pro XL frame only **DU24100**

ORDER SEPERATELY:

Adjustable Bulls eye Pro XL net **DU24110**
Adjustable Bulls eye Pro XL Hit me banner **DU24115**
Adjustable Bulls eye Pro XL custom banner **DU24116**



BULLS EYE TARGET

- For medium distance practice.
- Size: Ø 150 cm.

Bulls eye target **DU24150**

- EASYMARK SYSTEM & TARGETS -

SQUARE TARGET

- For medium distance practice.
- Size 150 x 150 cm square.
- Sloped from 60 cm at the front to 90 cm at the back.
- Optional banner frame attachment.
- Optional banner (see page 39).

Square target 150x150 cm **DU24301**
 Banner frame attachment **DU24302**



EASYMARK SYSTEM II

- Put a flagstick anywhere you like without using a hole cup.
- For ferruled flagsticks.
- Versatile tap-in anchor makes it easy to set up flags for special events on the range or around the clubhouse.
- 15 cm long, 8 cm diameter.

Easymark system II **SG26760**



RANGE FLAGS

- Simple and clear – range flags that fit regular flagpoles.
- Flag size (H) 100 cm x (W) 30 cm.
- Come in sets of 4:
 (White) 50 – (Red) 100 – (Yellow) 150 – (Black) 200.
- Combine best with 229 cm flagpoles & winter hole cups for additional stability.

Range flags **PC20001**



- DISTANCE SIGNS -



Photo: Stichting Sportacc. Hoenderdaal, The Netherlands

RECYCLED PLASTIC RANGE BANNERS

- Highly visible and high impact range banner.
- Extremely durable.
- UV stable.
- Recycled plastic with any distance in the illustrated colour combinations.
- Supplied with 2 posts.
- Size: 60 x 120 cm.

Available colour combinations:



PDR-RP-HOR



PAR AIDE PRACTICE RANGE SIGN

- Unbreakable distance sign.
- Easy to exchange rubber flaps.
- Rugged steel frame.
- Each sign needs 1 frame plus the required figure flaps.
- Flaps available in black and in yellow.
- Size: 60 x 100 x 60 cm.



Frame practice range sign		PA10200
Distance flap 0	Black:	PA10210-00
	Yellow:	PA10310-00
Distance flap 1	Black:	PA10210-01
	Yellow:	PA10310-01
Distance flap 2	Black:	PA10210-02
	Yellow:	PA10310-02
Distance flap 5	Black:	PA10210-05
	Yellow:	PA10310-05
Distance flap 7	Black:	PA10210-07
	Yellow:	PA10310-07

- RANGE BANNERS -

RANGE BANNER FRAME ALUMINIUM

- Unbreakable aluminium construction.
- Complete with ground sockets.
- Frame size: (W) 120 x (H) 126 cm.
- Banner size: (W) 120 x (H) 63 cm.

Frame only **DU29071**



NYLON RANGE BANNER

- Nylon banner, shot resistant.
- Yellow with black numbers.
- Size: 120 x 63 cm.



Range banner 50	SG31050	CA42161
Range banner 75	SG31075	CA42186
Range banner 100	SG31100	CA42211
Range banner 125	SG31125	CA42236
Range banner 150	SG31150	CA42261
Range banner 175	SG31175	CA42286
Range banner 200	SG31200	CA42311
Range banner 225	SG31225	CA42336
Range banner 250	SG31250	CA42361
Range banner 275	SG31275	CA42386
Range banner 300	SG31300	CA42411

PROMOTIONAL BANNER

- Present your sponsor on a highly visible range banner.
- Shot resistant material.
- Custom design to suit everybody's needs.
- Banners price includes full colour print.
- Mounted on an aluminium banner frame only.

Available in 2 sizes:

PROMOTIONAL BANNER

- Frame size: (W) 120 x (H) 126 cm.
- Banner size: (W) 120 x (H) 63 cm.

Promotional banner **DU29260**
Aluminium banner frame only **DU29071**



PROMOTIONAL BANNER XL

- Frame size: (W) 150 x (H) 150 cm.
- Banner size: (W) 150 x (H) 100 cm.

Promotional banner XL **DU29261**
Aluminium XL banner frame only **DU29070**

- INTERACTIVITY -

INTERACTIVITY ON THE GOLF COURSE

Interactivity and real fun are finally reaching the driving range – no longer a boring experience of just hitting balls in an outfield, but true data on a screen or on your phone, generated by high speed camera's and/or Doppler radar.golfer.



Concepts such as Toptracer Range deliver the same ball-tracking technology that traces the shots of the games best players on TV. Driving ranges equipped with Toptracer Range technology offer a fun, engaging, tech-driven experience that appeals to seasoned players, range rivals, friends, family members, and even first-time golfers.



The Ernest Sports ES15 bay divider gives immediate data on your phone or screen making your range visit an interactive session with true data! Fun and accurate figures making the experience appealing for every type of golfer.

- TARGET GREENS -



TARGET GREENS

Make your range more attractive by adding some nice highly visible targets to it. No problems collecting balls here as the pickers can drive straight over it. Duchell's target greens are sand filled to assure a real turf simulation by having a green that will really stop a ball like real turf would do.

These greens can be supplied as a standard package for self installation or can be installed by our specialized crew. A stable base is required for maximum performance.

Target Green 6 mtr diameter
Target Green 4 mtr diameter
Installation on request.

DU24206

DU24208



- PERIMETER NETTING -

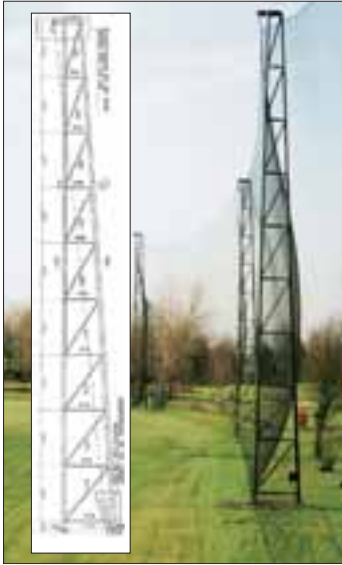

Picture taken at Golfcentre Amstelborgh
Amsterdam, The Netherlands

PERIMETER NETTING

Duchell can provide the full service for your netting requirements:

- Consulting.
- Engineered wind load calculations.
- Engineered drawings and specifications.
- Complete installation.



Picture taken at Golfplatz Sonnenalp
Ofterschwang, Germany

Duchell can consult about all your netting issues you may have. From areas that need simple 3 to 6 metres construction up until full fencing of 24 metres height.

Do ask for a custom quote.

DRIVING RANGE NETTING

- High quality range netting for different purposes.
- Use our expertise to choose the right netting.
- Offer for complete construction on request.
- Different colours available.



PE SIDE NETTING BLACK

- Side net quality.
- Mesh: 29 x 29 mm.

DU24001 per m2

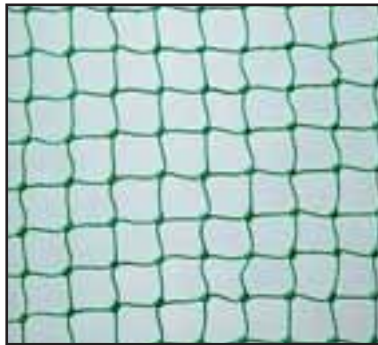

PE HITTING NET GREEN

- Long distance hitting net.
- Mesh: 27 x 27 mm.

DU24002 per m2



HEAVY NYLON NET WHITE

- Heavy duty net for cages.
- Mesh: 27 x 27 mm.

DU24004 per m2

- HITTING CAGES -

PRO RETURN NET

- Solid design; high quality polyester netting & steady spring steel frame.
- For both indoor & outdoor use.
- Lightweight and portable; comes with durable carrying bag.
- Set-up in seconds; retracts instantly for storage.
- Size: height x width: 180 x 270 cm.
- Weight: 6 kg.

DU24070



IMAX HITTING CAGE

- Aluminium frame with aluminium die-casted corner pieces.
- Supplied knock-down, easy to handle and mount.
- Size: 300 x 300 x 300 cm.

DU24060



- LED LIGHTING -

LIGHT UP YOUR RANGE WITH LED!



NOT JUST LED LIGHTING, BUT SPECIALISED LED LIGHTS MADE FOR GOLF

LED lights on the driving range, require specific knowledge of golf.

In the last 10 years, Duchell has built up a lot of experience in driving range lights, resulting in a balanced choice of LED lights.

Specific requirements for LED lights on the driving range:

- The right colour for the best reflection on a golf ball for maximum visibility.
- The right spread of light, being achieved using different lenses, to create extreme visibility of the golf ball.
- Tailored possibilities for any demand, enabling to follow the ball up to an amazing 400 meters!
- Also available for putting/chipping greens.

Advantages of LED lights, compared to conventional lamps:

- Low energy costs (around 4.5x less energy).
- Low maintenance.
- 60.000 hours lifespan.
- On/Off possibilities, without any delays.
- Plug and play installation – no control box needed.

Duchell LED light 200W

DULED200W

Duchell LED light 400W - 15 degrees

DULED400W-15

Duchell LED light 400W - 45 degrees

DULED400W-45

All other LED lights, Watts and degrees, on request.

- LED LIGHTING -

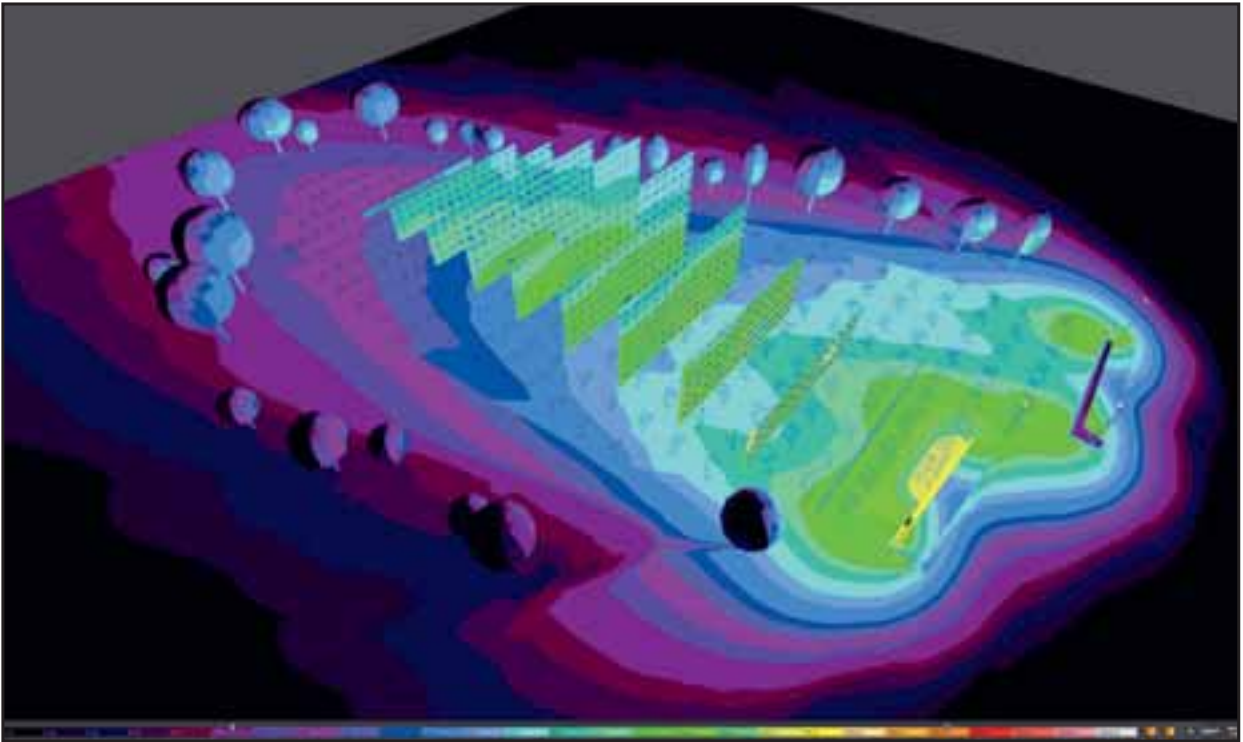

Duchell can provide a detailed light plan showing 'visibility' anywhere on the driving range following the customers demand for short and/or long distance view.

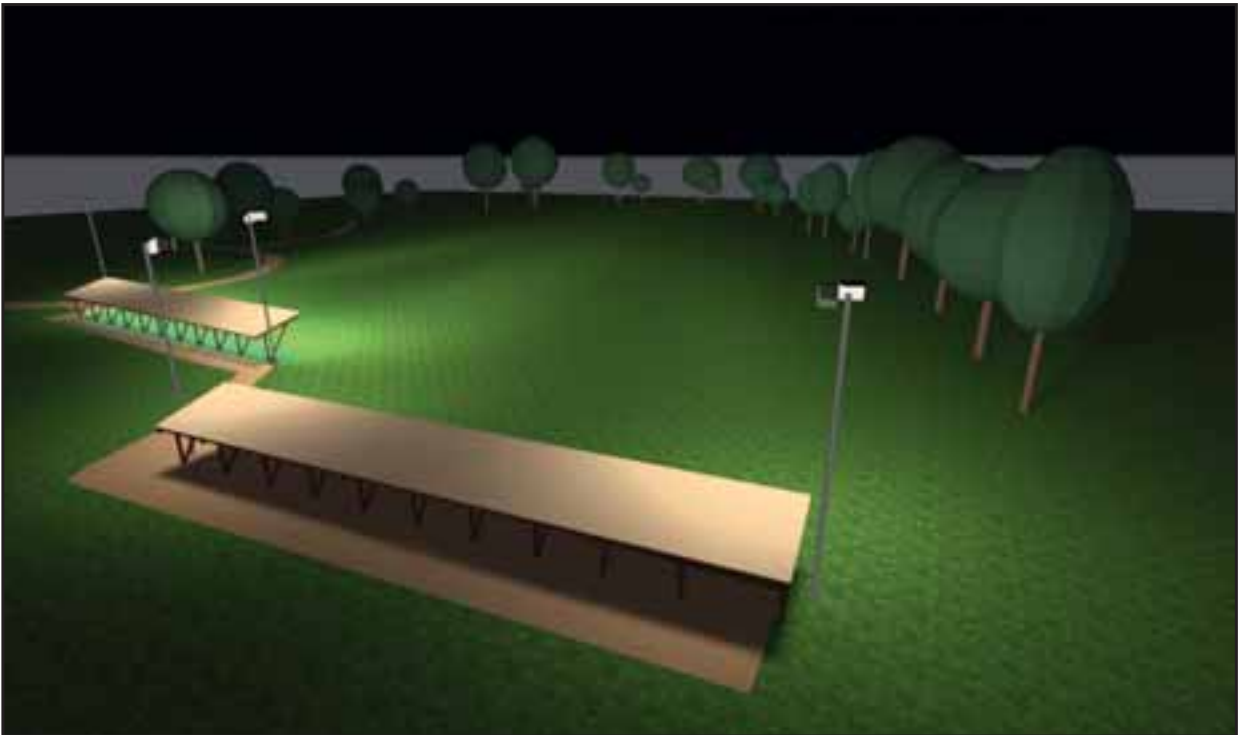

Solutions depend on the local situation; reflection on trees, available posts, height of building etc. are all taken into account when coming up with the best solution for each customer.

- BALL PICKERS -



THE IMAX BALL PICKER

- The best lightweight picker ever made!
- Fully galvanised.
- Polycarbonate discs for the best durability.
- Two galvanised baskets per unit for easy emptying.
- Easily extendable from a 3-gang to a 5-gang picker.



IMAX 3-GANG BALL PICKER

- Ball capacity: 2.500 balls.
- Size: 2,85 mtr x 1,95 mtr.

MX230003

IMAX 3-GANG TO 5-GANG EXTENSION

- Increases ball capacity to 4.000 balls.
- Increases size to 4,95 mtr x 1,95 mtr.

MX230035



Large front wheel for extra stability.

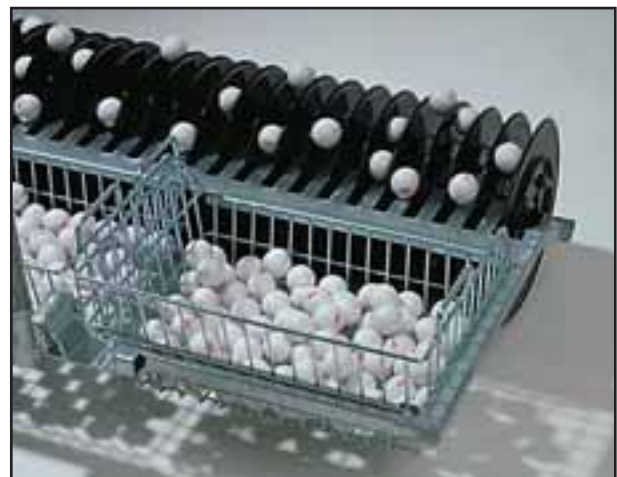

High quality galvanised baskets.

- BALL PICKERS -



THE EPIC BALL PICKER

- Best quality/value rating in the business!
- Tough construction and sturdy braces make for a stable picking run.
- Also available in a 5-gang variation (add extension set).



EPIC 3-GANG BALL PICKER

- Ball capacity: 2.500 balls.
- Size: 2,77 mtr x 2,39 mtr.

P71903N

EPIC 3-GANG TO 5-GANG EXTENSION SET

- Increases ball capacity to 4.000 balls.
- Increases size to 4,95 mtr x 1,95 mtr.

P71903N/5



Large front wheel for extra stability.



High quality epoxy coated baskets.

- BALL PICKERS -

RANGE SERVANT¹

THE RANGE SERVANT INLINE BALL PICKER

- An all terrain performer.
- Galvanized steel frame available in light and heavy duty configuration.
- Designed to pick up golf balls anywhere, anytime.
- Available with unbreakable multiflex discs or the most heavy duty version with rubber tires for extreme durability.
- Comes in three sizes: Midi (6 baskets), Maxi (10 baskets) and Jumbo (14 baskets).
- Also available with hydraulic emptying - see website.

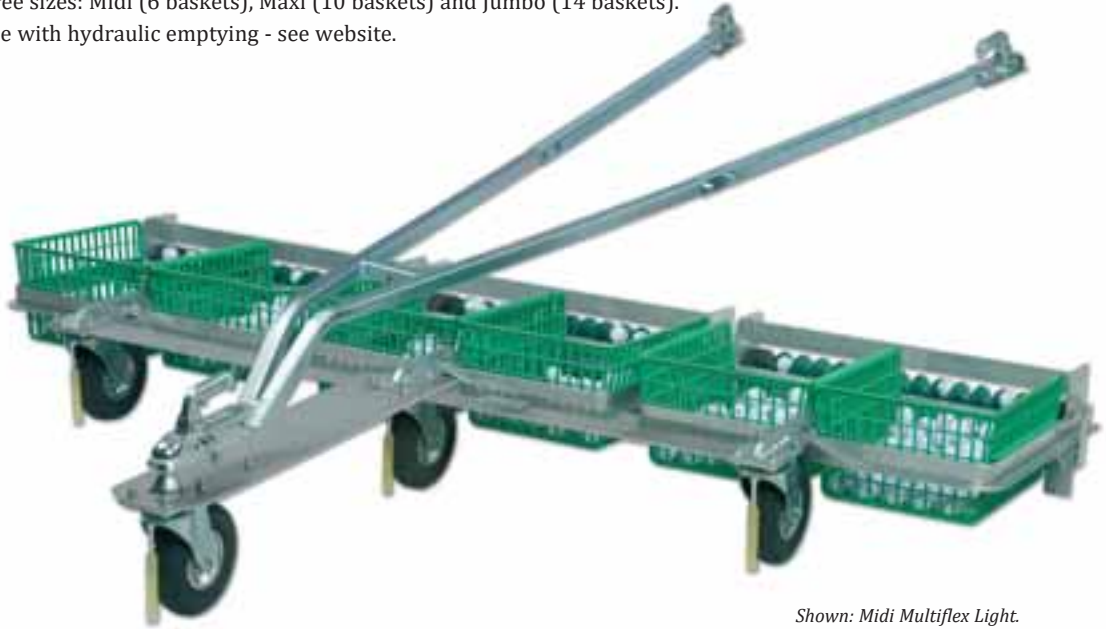

Shown: Midi Multiflex Light.

MIDI MULTIFLEX BALL PICKER

- Ball capacity: 2.400 balls.
- Size: 2,5 mtr x 1,8 mtr.

Light

RSPDM0000

Heavy duty

RS310005

JUMBO MULTIFLEX BALL PICKER

- Ball capacity: 5.600 balls.
- Size: 5,9 mtr x 1,8 mtr.

Heavy duty

RS310025

MAXI MULTIFLEX BALL PICKER

- Ball capacity: 4.000 balls.
- Size: 4,2 mtr x 1,8 mtr.

Light

RSPDM0085

Heavy duty

RS310015

MIDI HEAVY DUTY BALL RUBBER PICKER

- Ball capacity: 2.400 balls.
- Size: 2,5 mtr x 1,8 mtr.

Heavy duty

RS300000



Shown: Midi Multiflex Ball Picker Light.



Shown: Midi Heavy Duty Rubber Ball Picker.

- BALL PICKER SPARE PARTS -



SPARE PARTS RANGE SERVANT PICKER

Spare disc multiflex for Range Servant picker
Spare end disc multiflex for Range Servant picker
Spare plastic basket for Range Servant picker
Spare steel basket for Range Servant picker
Do ask for prices and availability of other spare parts.

RSPBM0038
RS302040
RSOFM0012
RS300400

RANGE SERVANT

SPARE PARTS IMAX PICKER

Spare disc for Imax
Spare nylon spacers for Imax disc
Complete picker roll for Imax picker
Spare basket for Imax picker
Do ask for prices and availability of other spare parts.

MX530019
MX530035
MX530010
MX530020

Imax

SPARE PARTS EPIC PICKER

Spare middle disc for Epic picker
Spare end disc for Epic picker
Complete picker roll for Epic picker
Spare basket for Epic picker
Do ask for prices and availability of other spare parts.

PBP-2001-99
PBP-2001-98ED
PBP-2001-95COMP
PBP-2001-26

EPIC

- MANUAL BALL PICKERS -



RANGE SERVANT

RANGE SERVANT MANUAL BALL PICKER

- Large capacity manual picker, holds about 800 balls.
- Easy to operate, maintenance free.
- 84 cm wide, capacity 800 balls.

RS310035



EPIC MANUAL BALL PICKER

- Mini push picker, extremely light to operate.
- 50 cm wide, capacity 300 balls.

PBC/MH

Optional Front wheel

PBC/MH-FW



BALL SCOOP

- Green polyester-coated scoop head fitted on to long fibreglass head.
- 2 metres long.
- Easy replacement of scoop head.

P506501

- MANUAL BALL COLLECTORS -

THE UNPLUGGER

- Easy unplugging of balls stuck in the grass.
- Just push and bend, no force or bending over needed.

DU23015

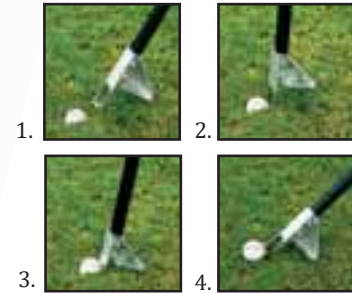
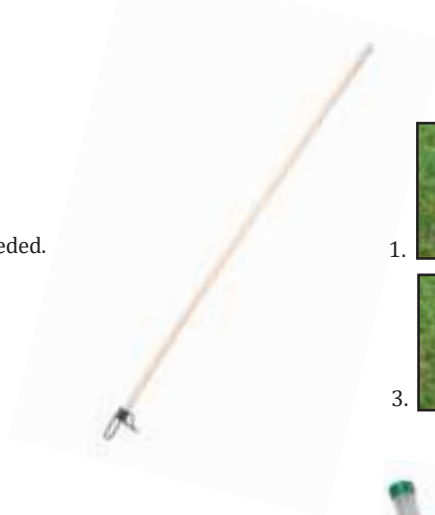

CLIKKA TUBE

- Economic solution for easy picking.
- Holds 21 balls.

DU29501



STEEL CLIKKA TUBE

- Heavy duty version of the klikka tube.
- Holds 21 balls

DU29501S



CLIKKA BAG

- Larger easy picking variation.
- Holds 55 balls.

DU29502



ROLLING BALL PICKER

- Make collecting balls quick and easy.
- Lightweight, compact and easy to use.
- Head features 60 metal spokes.
- Balls are easily removed by separating the spokes.
- 127 cm long handle.
- Holds 80 balls.

PA10755



- BALL WASHERS -

RANGE SERVANT



RANGE SERVANT BALL WASHERS

- Heavy duty washer for perfect cleaning.
- Made of galvanised steel.
- Cleaning through a robust rotating nylon brush.
- Grass, leaves and damaged balls are sorted out via the hopper grid.
- Standard with a 1.000 ball hopper.
- Also available with XL-hopper which can hold 3.000 balls.
- Power: 230V, 50Hz.
- Weight: 129 kg.
- Size: 106 x 77 x 87 cm.



BT1300 / BT1950



XL-Hopper only

RANGE SERVANT BALL WASHER BT1300

Capacity: 14.000 balls p/h **RSWGM0000**

RANGE SERVANT BALL WASHER BT1950

Capacity: 26.000 balls p/h **RS220000**

RANGE SERVANT BALL WASHER BT1300 WITH XL-HOPPER

Including XL-hopper **RSWGM0045**

RANGE SERVANT BALL WASHER BT1950 WITH XL-HOPPER

Including XL-hopper **RS220001**

XL-HOPPER ONLY

Capacity: 3.000 balls **RS221400**

- BALL WASHERS -

RANGE SERVANT

RANGE SERVANT BALL WASHER BT1000

- Stand-alone unit with a 75 litres water tank.
- Washes 18.000 balls per hour.
- Standard hopper will hold 700 balls.
- Self-feeding agitator ensures feeding without operator attendance.
- Direct drive motor eliminates all problems associated with belts and pulleys.
- All galvanised and stainless steel parts.
- Size: 128 x 83,5 x 63,9 cm.
- Capacity: 18.000 balls p/h

Ball washer BT1000

RSWBT0001



VINK III BALL WASHER

- Made of stainless steel.
- Washer and elevator in one.
- Fastest system in the Industry washing 1.250 balls per minute.
- Eight rotating brushes transport your balls into the dispenser.
- Water sprays from top to bottom giving a good washing operation.
- Can be connected to almost all types of dispensers with a bracket.
- Power: 230V, 50Hz.
- Weight: 40 kg.
- Size: 90 x 112 x 87 cm.

Capacity: 1.250 balls p/m

MX54002

Bracket for Imax dispenser

MX54101

Bracket for Range King dispenser

MX54102

Bracket for Range Servant dispenser

MX54103

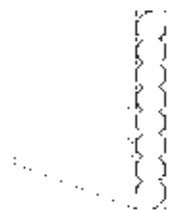

- BALL WASHERS -



TWISTER BALL WASHER 1

- Heavy duty nylon brush rotates inside the patented steel spiral.
- Small rocks and ball fragments fall through the spiral, reducing jamming or lock ups.
- Easy access to water tank and open spiral with hinged top.
- Electrical supply disconnects when accessing the turning parts.
- Fast and easy cleaning of the tank by using a large threaded drain.
- Top holds 600 balls.
- Washing capacity of 15.000 balls per hour.
- Size: 85 x 49 x 78 cm.

MX55100



Hinged lid for easy access.



The rotating brush moves the balls through the spiral.



TWISTER BALL WASHER 4

- A washer and elevator in one machine!
- Balls are transported to machine (next to the washer) by a composite loader wheel.
- Extended hinged top holds approximately 1.000 balls.
- Built in ball stop (eliminates stack load on loader wheel).
- Enclosed exit tube eliminates jamming.
- View ports on spiral and exit tube for easy checking.
- Washing capacity 29.000 balls per hour.
- Size: 130 x 59 x 97 cm.

MX55400



The rotating brush moves the balls through the spiral.



Hinged lid for easy access.



After washing the composite loader wheel pushes the balls into the feeder pipe.

- BALL TRANSPORTATION SYSTEMS -

RANGE SERVANT



ELEVATORS

Elevator for RS Ultima 8 & 15	140 cm	RSEGM0001
Elevator for RS 4, 8, 11 & 15	180 cm	RS410000
Elevator for cone top dispensers	210 cm	RSEHM0001

BLOWERS

Blower module 1,5KW	RS800010
Blower module 2,2KW	RS800020
Blower module 3,0KW	RS800030
Connecting blower	RS800021



BLOWFILL MANIFOLD

Blowfill manifold	RSBCM000
-------------------	-----------------

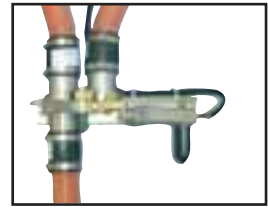

THE PRE-SOAKER 4000

- Loosens mud, dirt or grass caked on the golf balls.
- 300 Litre tank holds 4.000 balls.
- Elevator with adjustable speed to match speed of any ball washer (ball washer not included).
- Sits on lockable castor wheels for easy moving for cleaning and maintenance.
- Safe 90 cm load height.
- Lift out components for easy cleaning.

Soaker 4000

RSWIM0004



- BALL TRANSPORTATION SYSTEMS -

RANGE SERVANT

Duchell has over 30 years of experience in installations of Ball Management systems; from a 'simple' stand-alone system up to pickers with hydraulic dump system through blowing balls underground over 250 metres.

For a new installation we advise to get a Duchell expert on site as early as you can to integrate your system in your construction planning; Lean on our endless experience, get practical advice and let us save money for you!



Stand-alone system consisting of a Range Servant BT1950 washer, 2,10 metre elevator and an Ultima 20 balldispenser.

FRONT VIEW



TOP VIEW

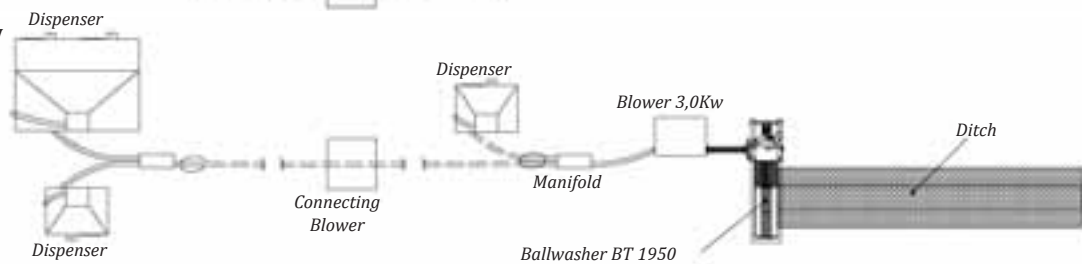

RANGE SYSTEMS

System operated with an hydraulic ball picker, ditch, washer and blowfill system. This system eliminates all manual lifting of the golfballs and blows the balls underground (over 250 metres) to 3 different balldispensers.

ON THE RANGE

- FLAT TOP BALL DISPENSERS -

RANGE SERVANT

FLAT TOP DISPENSERS

- Machines made only of galvanised steel and aluminium.
- Available with different payment systems.
- Easy to clean and maintain.
- To be filled either manually or by elevator.
- Motor: 70 Watt, Ultima version 17 Watt.
- Voltage: 230V, 50Hz.
- Water consumption: 0,5 ltr / turn.



ORIGINAL DISPENSING SYSTEM

- Balls are forwarded and cleaned by a central brush.
- Quantity of dispensed balls changes by manually adjusting the dispensing pins.
- Dispensing by grooved rotating dispensing tube.
- Sturdy system, easy to clean and maintain.



ULTIMA DISPENSING SYSTEM

- Patented single ball dispensing system.
- Conveyor belt system with digital ball count.
- Gives possibility to dispense all ball quantities imaginable.
- Can only be used in combination with a ball washing system.

	RS4	RS8	ULTIMA 8	RS11	RS15	ULTIMA 15
Ball capacity	5.200	8.000	8.000	11.000	16.000	16.000
Ball count	1x9 - 999x17	1x9 - 999x17	1-999	1x13 - 999x23	1x9 - 999x17	1-999
Height (cm)	149	149	133	149	133	133
Width (cm)	101	101	101	125	101	101
Depth (cm)	55	76	76	101	152	152
Weight (kg)	82	84	84	90	135	137

RS150010

RS180000

RSDKM0000

RS110007

RSDQA0000

RSDUA0000

- CONE TOP BALL DISPENSERS -

RANGE SERVANT

CONE TOP DISPENSERS

- Machines made only of galvanised steel and aluminium.
- Available with different payment systems.
- Cone top for extra storage space.
- Easy to clean and maintain.
- To be filled either by elevator or blow fill system.
- Motor: 70 Watt, Ultima version 17 Watt.
- Voltage: 230V, 50Hz.
- Water consumption: 0,5 ltr / turn.



* RS Combi includes washer & elevator

	RS12	ULTIMA 12	RS COMBI*	RS18	RS19	ULTIMA 19
Ball capacity	12.000	12.000	14.000	18.000	20.000	20.000
Ball count	1x9 - 999x17	1-999	1-999	1x13 - 999x23	1x9 - 999x17	1-999
Height (cm)	222	205	222	222	222	205
Width (cm)	101	101	125	125	101	101
Depth (cm)	76	76	76	101	152	152
Weight (kg)	84	84	90	135	140	140
	RS110000	RSDLM0000	RSGBM0000	RS140000	RSDSA0000	RSDVA0000

ON THE RANGE

- DUAL BALL DISPENSERS -

RANGE SERVANT

DUAL BALL DISPENSERS

- Machines made only of galvanised steel and aluminium.
- Available in both standard and ultima version.
- Seperate electrical system per unit for maximum security.
- Available in two capacity sizes.
- To be filled by either elevator or blow fill system.
- Available with different payment systems.
- Motor: 2 x 70 Watt, Ultima version 2 x 17 Watt.
- Voltage: 230V, 50Hz.
- Water consumption: 2 x 0,5 ltr / turn.



	RS20 DUAL	RS20 ULTIMA DUAL	RS45 DUAL	RS45 ULTIMA DUAL
Ball capacity	22.000	22.000	45.000	45.000
Ball count	9x1 - 999x17	1-999	9x1 - 999x17	1-999
Height (cm)	238	222	238	222
Width (cm)	202	202	202	202
Depth (cm)	76	76	152	152
Weight (kg)	168	173	240	249
	RS120000	RSDMM0000	RS130000	RSDNM0000

- TOKENS -

COINS & TOKEN MECHANISM

- All ball dispensers can be equipped with multiple coin or token options.
- Pure mechanical function.
- 500 pieces in a box.

EURO COIN MECHANISM

€ 0,50

€ 1,00

€ 2,00

Token mechanism DU-001

Token mechanism DU-002

Token mechanism DU-003

Token mechanism DU-004

Token mechanism DU-005

Token mechanism DU-006

Token mechanism DU-007

Token mechanism DU-008

Token mechanism DU-009

Token mechanism DU-010

MX5381522

MX5381521

MX5381520

DU23110

DU23111

DU23112

DU23210

DU23211

DU23221

DU23231

DU23241

DU23251

DU23261



TOKEN DUCHELL 001

DU23100



TOKEN DUCHELL 002

DU23101



TOKEN DUCHELL 006

DU23220



TOKEN DUCHELL 010

DU23260



TOKEN RS 4

RS108700/4

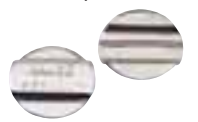

TOKEN RS D

RS108700/D



TOKEN DUCHELL 003

DU23102



TOKEN DUCHELL 007

DU23230



TOKEN RS 1

RS108700/1



TOKEN RS A

RS108700/A

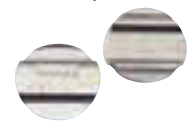

TOKEN RS E

RS108700/E



TOKEN DUCHELL 004

DU23200



TOKEN DUCHELL 008

DU23240



TOKEN RS 2

RS108700/2



TOKEN RS B

RS108700/B



TOKEN RS F

RS108700/F



TOKEN DUCHELL 005

DU23201



TOKEN DUCHELL 009

DU23250



TOKEN RS 3

RS108700/3



TOKEN RS C

RS108700/C

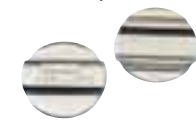

TOKEN RS G

RS108700/G

- PAYMENT SYSTEMS -

XAFAX - THE STATE OF THE ART SOLUTION FOR CASHLESS PAYMENTS ON YOUR GOLF COURSE!

Do you want to offer your guests and members a payment solution they are used to in this modern world?; Xafax has it all. From a proximity card with club- or sponsorlogo to using any other device as an identifier. Xafax makes it easy and simple to pay at the club counter or on the Internet. Studies have proven that trouble free, simple ways to pay increase revenue.

Cashless payment options for ball dispensers:

- All bank debit and credit cards.
- National golf federation cards.
- Private club card.
- Mobile app.
- QR tickets.

Features:

- Central management.
- Webservice interfaces.
- Statistics and reporting functions.

Benefits:

- Easy, safe and smart cashless payments.
- Increased customer satisfaction.
- Wide range of services for customers.
- Reduced workload.
- Increased customer loyalty.

POS Integration / Link to databases:

- Reservation software.
- Cash registration software.



Multiple options for identifiers.

No cash investment needed, monthly lease rates:

Vending:

XA7270LAN	Cashless Vending terminal per month
XA72QR	QR code scanner per month
XA9500049	Payter Din rail per month
XA7224UB	Mifare USB reader/writer per month

Hosting:

XA5675	Netpay Online per month
XA5705	Netpay Manager per month
XA9500044	Hosting Terminal per month

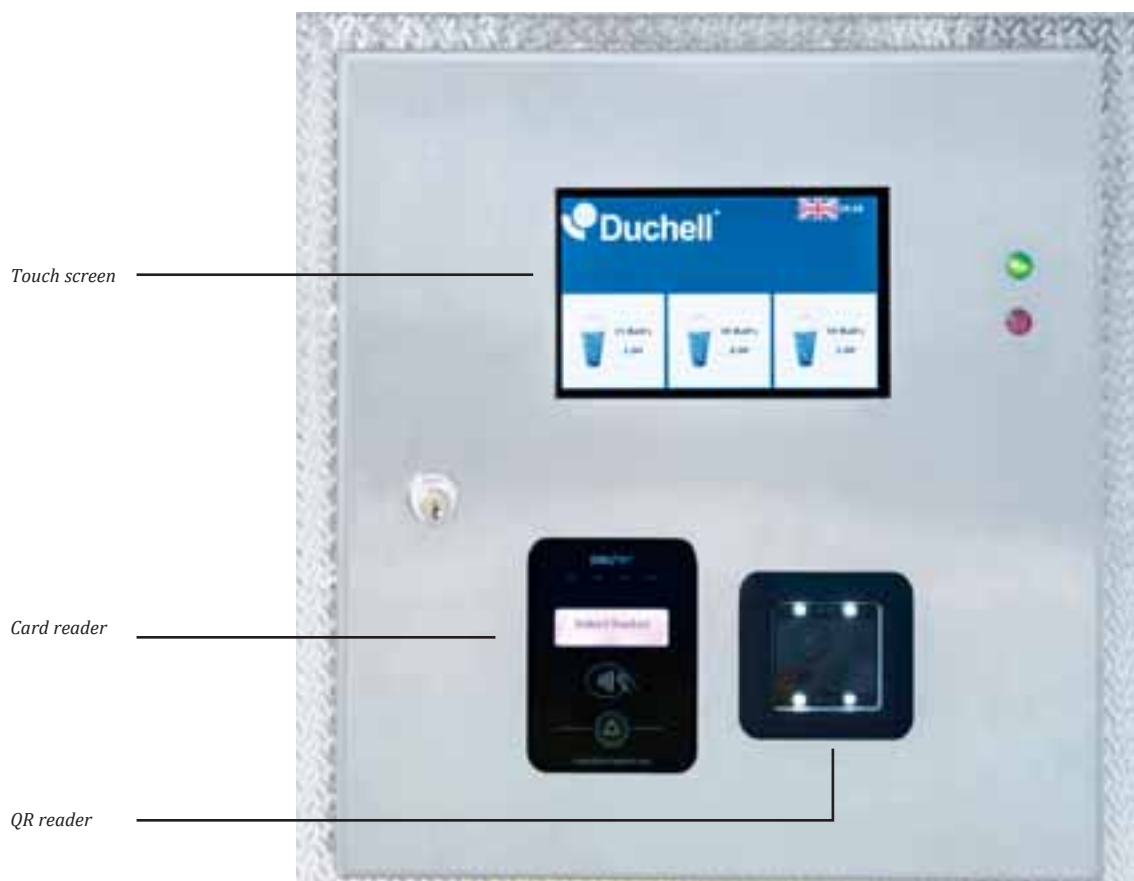

- PAYMENT SYSTEMS -



WHAT'S AN E-KEY?

The e-key is essentially a small computer chip encased in a stainless steel container that resembles a watch battery in size and shape. The e-key is designed to withstand punishment and abuse that would render any other card system inoperative.

ABOUT THE READER

The e-reader is a weatherproof reader. It uses special e-keys instead of the conventional smart cards. E-reader comes with display for information and instructions.

Every e-range system comes complete with software and key-loading device. Available in 4 versions depending on the level of information and possible reports required.

The basic VSD version offers: 1 selection price/size, revalue customer e-keys and revalue software. The extended versions can offer a data carrier to download events from the reader, a "void en replace" lost and stolen accounts option, all sorts of graphics, reports and spreadsheets as well as a PIN code option to replace tokens. This PIN code uses wireless Pintronics software. Activate your ball dispenser with a single use PIN number, just like the carwash. Simply punch in your PIN number and receive the appropriate bucket of balls.



2 Year warranty on all readers

E-key VSD	CC26000
E-key version 4-6-8	CC26003
E-reader VSD version	DC26000
E-reader version 4	DC26001
E-reader version 6	DC26002
E-reader version 8	DC26003
Additional Reader VSD Version	DC26101
Additional Reader Version 4-6-8	DC26201
E-Range Installation	DC26007
E-Range Starters Training	DC26006
E-Range Support Pack, annual fee	SERVA



E-keys



Ask us for a quotation for the e-key holder.

A complete technical overview is printed on the next page.

- PAYMENT SYSTEMS -



Instantly convert any single size dispenser to 3 sizes! Works in any ball dispenser!	e-Range Version VSD	e-Range Version 4	e-Range Version 6	e-Range Version 8
	Credit value used by each system >>> Basket	Money	Money	Money
3 Selection Sizes - 3 Prices	✓	✓	✓	✓
Revalue Customer e-keys	✓	✓	✓	✓
Erase and re-use customer eKeys 1000's of times	✓	✓	✓	✓
Revalue Software (Revalue Station on PC)	✓	✓	✓	✓
Set an expiry date for each individual account		✓	✓	✓
Automatic revalue resets account balance daily		✓	✓	✓
Automatic reset value can be set up for each account		✓	✓	✓
Data carrier to download events from the reader		✓	✓	✓
View up-to-date customer balances		✓	✓	✓
Void & Replace lost or stolen accounts		✓	✓	✓
View & Print Transaction (event) reports			✓	✓
View & Print by customer, type, event			✓	✓
View & Print Monthly sales graphs			✓	✓
View & Print Weekly sales graphs			✓	✓
Print up-to-date customer balances			✓	✓
Set a discount for each individual account			✓	✓
Export reports to your favorite spreadsheet			✓	✓
E-mail reports			✓	✓
Generate a single use PIN to replace tokens				✓
Print Single Customer PIN receipt to replace tokens*				✓
Print batches of PINs for group or tournament play				✓
Point of Sale Software Integration				✓
Optional Bill Validator Support		✓	✓	✓

New	e-Range PLUS software!	Even easier to use
<p>e-Range Version 8 PLUS Software is required for PIN use in more than one ball dispenser e-Range PLUS requires a communication cable from the dispensers to a computer** e-Range PLUS V4, V6, and Version 8 systems have a range of 4000 feet e-Range PLUS is not computer dependant. If your computer fails, the system still works! Happy Hour pricing - change the selling price automatically at preset times of the day.</p>		



NAYAX CARDREADER FOR A COMPLETE UNATTENDED SOLUTION - MORE CONVENIENCE - MORE SALES!

- Accepts Debit & Credit Cards for transactions below pin code requirement.
- Swipe, contact or contactless.
- Stand alone on 3G data contract.
- Service agreement and data contract per month.
- Remote software updates, monitoring and management.
- Remote service with service contract.
- Compatible with any dispenser.
- Easy to install, simple to use.
- Payment for transactions is received weekly.
- Clearing costs based on a percentage of the accumulated sales.

Cashless Terminal	DC27001
Installation costs	DC27010
Service agreement (per month)	DC27011
Activation charge	DC27012



- BAG & CADDY LOCKERS -

H&D GOLF LOCKERS

- High quality metal lockers, keep your locker room organised and rodent free.
- Available in many RAL colours.
- Supplied with cylinder locks and adjustable feet.
- Standard electro caddy lockers.



Electro caddy locker



*Adjustable battery support
HD4953*



Ventilation holes



*Wheel supports
HD4951*



*Door organiser
HD4952*

- BAG & CADDY LOCKERS -

TOP BAG & CADDY LOCKERS

- Size: 1245 x 550 x 550 mm
- HD4911**

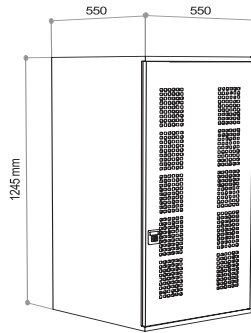

TRIPLE TOP BAG & CADDY LOCKER

- Size: 1245 x 1650 x 550 mm
- HD4911-3**

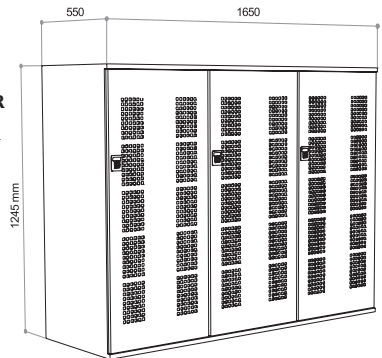

BOTTOM BAG & CADDY LOCKER

- Size: 1245 x 550 x 550 mm
- HD4910**

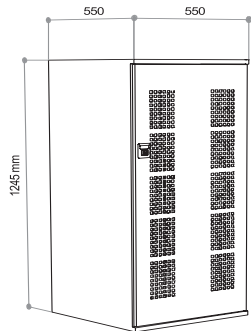

TRIPLE BOTTOM BAG & CADDY LOCKER

- Size: 1245 x 1650 x 550 mm
- HD4910-3**

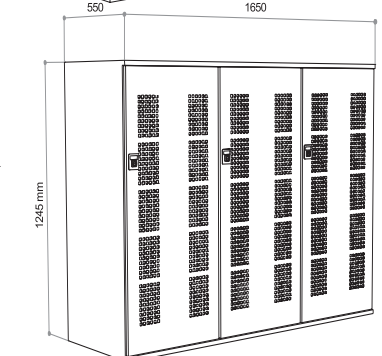

TOP FAMILY BAG LOCKER

- Size: 1245 x 825 x 550 mm
- HD4921**

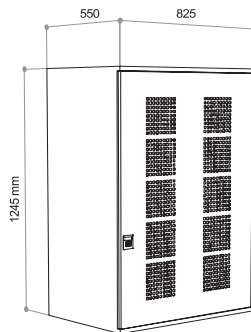

DOUBLE TOP FAMILY BAG LOCKER

- Size: 1245 x 1650 x 550 mm
- HD4921-2**

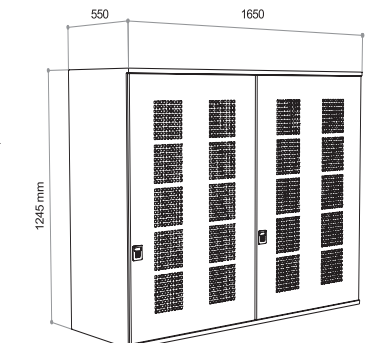

BOTTOM FAMILY BAG LOCKER

- Size: 1245 x 825 x 550 mm
- HD4920**

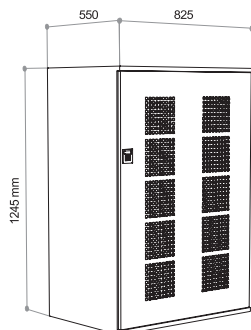

DOUBLE BOTTOM FAMILY BAG LOCKER

- Size: 1245 x 1650 x 550 mm
- HD4920-2**

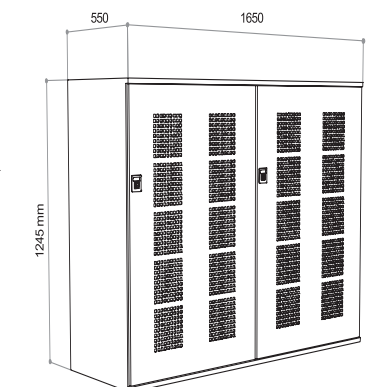

ELECTRO CADDY LOCKER

- Size: 1245 x 825 x 1100 mm
- HD4950**

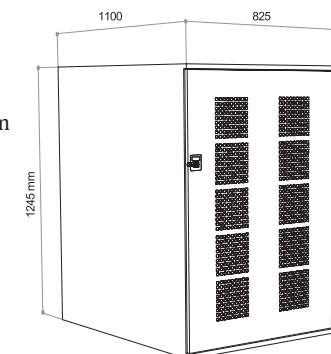

- BAG & CADDY LOCKERS -

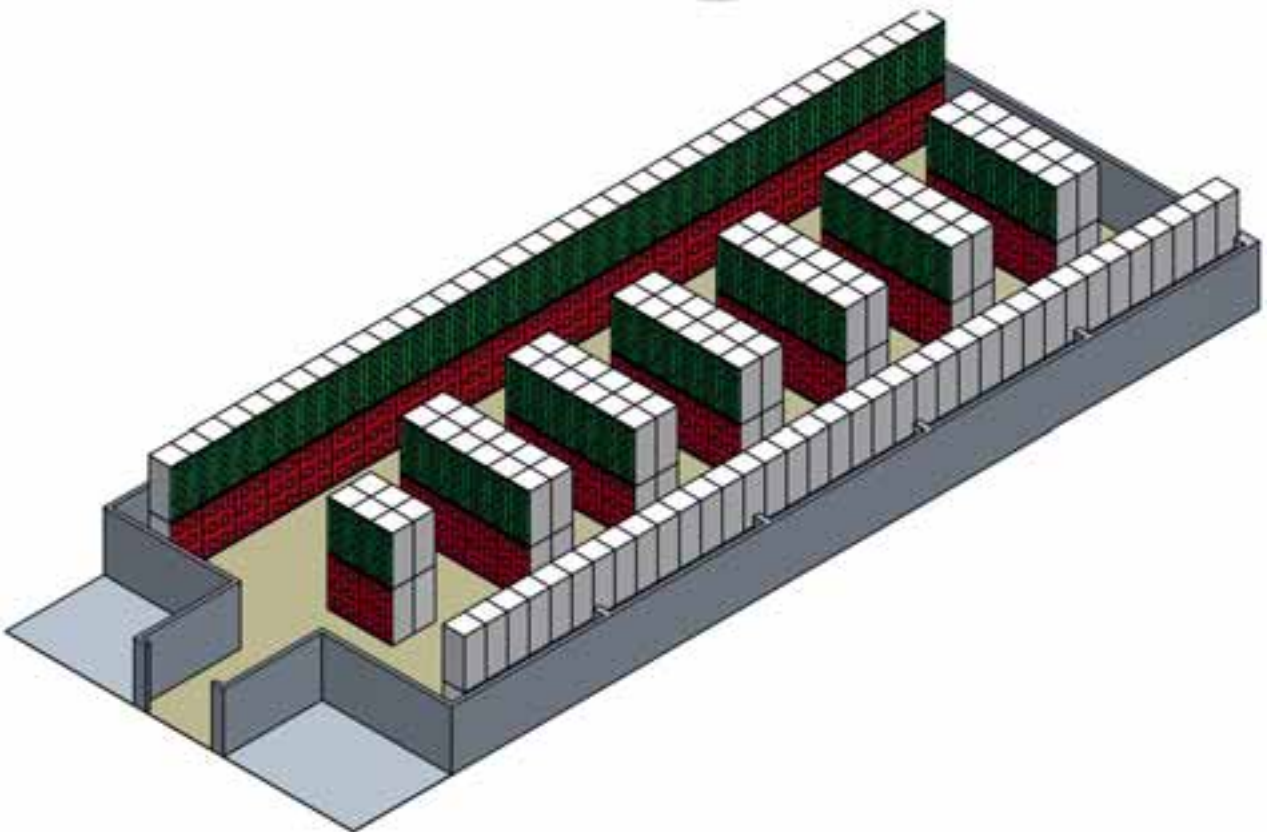
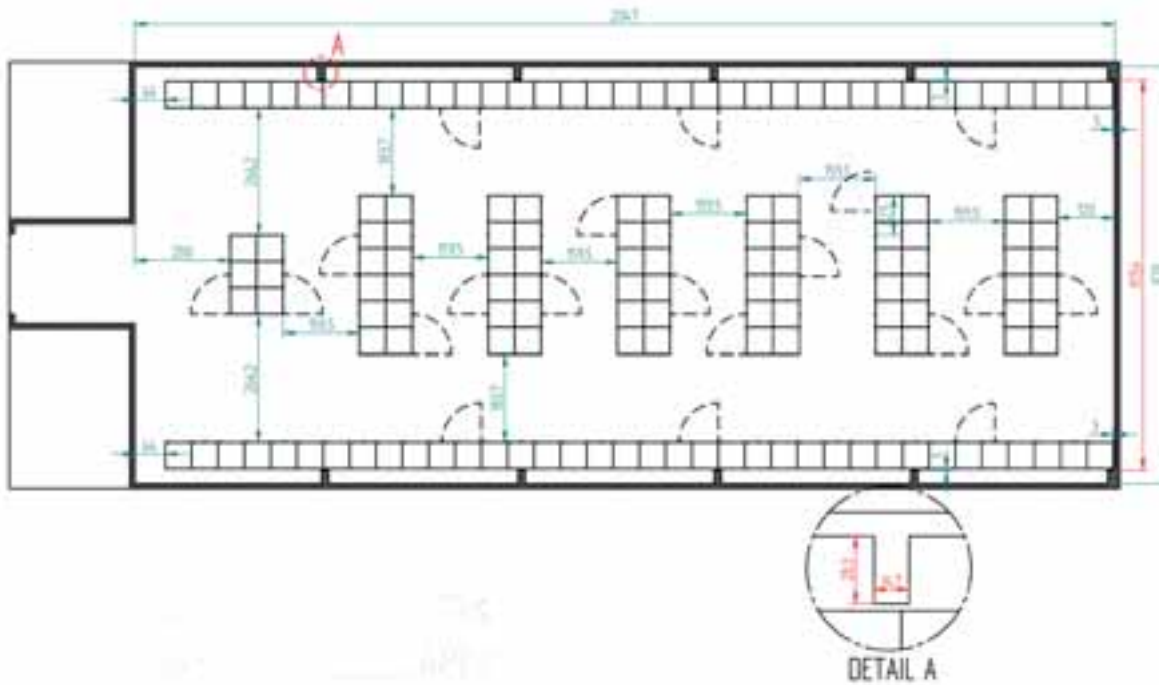

DO ASK US FOR ADVICE AND A LOCKER PLAN - BASED ON THE DRAWING OF THE BUILDING WE CAN PROVIDE DETAILED 2- AND 3D DRAWINGS OF THE INSTALLATION.

ON THE COURSE

Caddy Books	68
Score Cards	69
Teak Maintenance	70
Signage	71 - 73
Tee Signs	74 - 75
Ball Washers	76 - 84
Ball Washers Ensembles	78 - 79
Club Washers & Parts	85 - 86
Tee Markers	87 - 89
Broken Tee Caddies	90 - 91
Competition Markers	92 - 93
Distance Markers	94 - 98
Traffic Control	99
Hazard Markers	100 - 101
Traffic Control	102 - 103
Divot Mix Containers	104 - 105
Litter Bins	106 - 111
Water Coolers	112
Tee Towels	113
Ball Rack & Rental Trolleys	114
Flags	115 - 121
Flagsticks	122 - 129
Wooden Flagsticks	130
Measuring Systems	131
Placement Markers	132
Placement Flags	133
Putting Cups & Accessories	134 - 141
Event cups & Sure putt	140
Footgolf	142 - 143
Practice Green Markers	144 - 147
Junior Flags	148 - 149
Benches	150 - 151
On The Tee Accessories	152
Clocks	153
Atomic Clock	154
Information Signs	155 - 159
Rakes	160 - 169
Bunker Stamps	169
Shoe Cleaners	170 - 173
Cleaning Systems	174

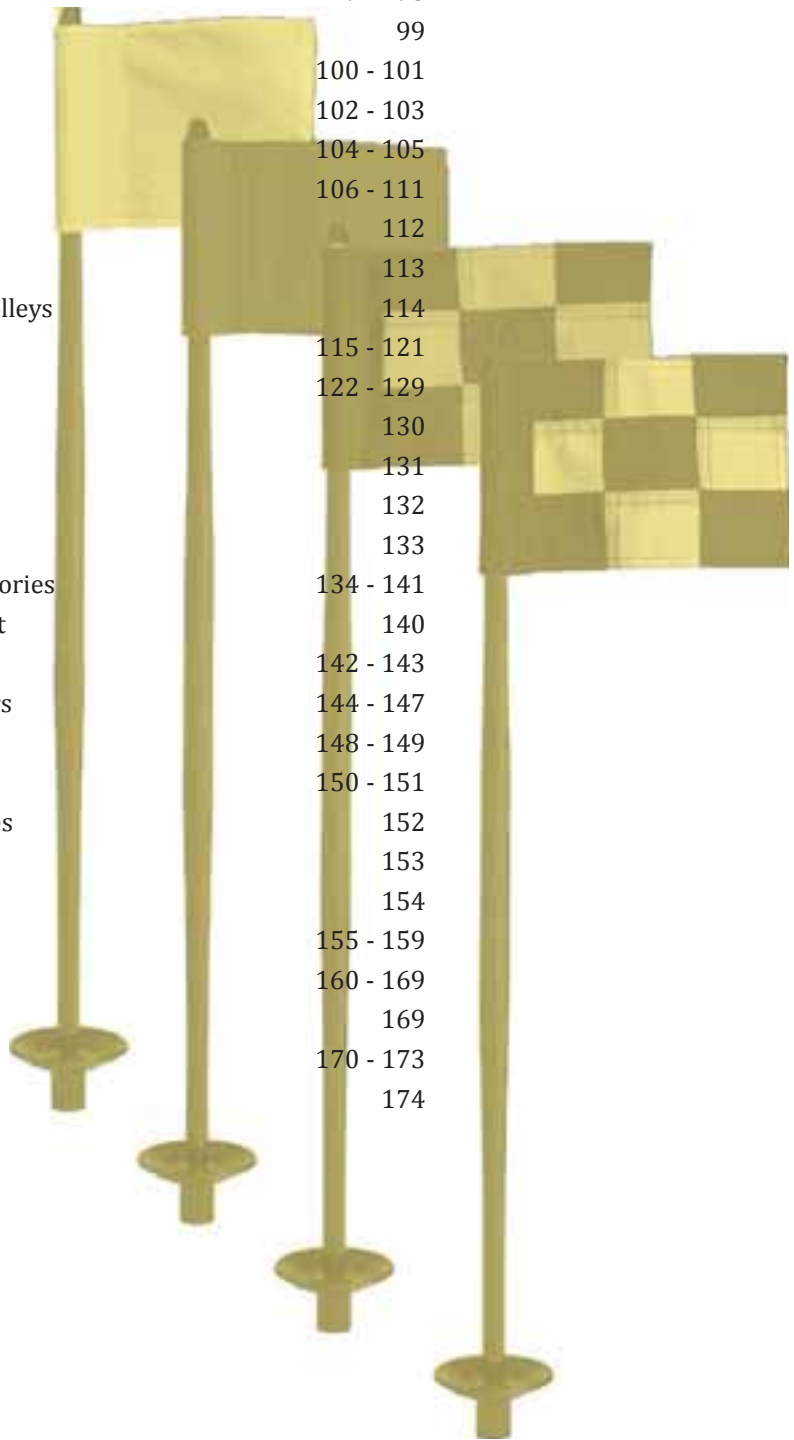

- CADDY BOOKS -



STANDARD GRAPHICS - STAPLED BOOKLET

- 1 page hole (up to 32 pages).
- 2D graphics.
- 165 mm x 95 mm.
- Full colour.
- Laminated covers.
- Stitched booklet on short or long edge.

CGSSSESTD

TOUR INSPIRED - STAPLED BOOKLET

- 2 page hole (up to 48 pages).
- 165 mm x 95 mm.
- Full colour.
- Laminated covers.
- Stitched booklet on short or long edge.

CGSSSETOUR

3D GRAPHICS - STAPLED BOOKLET

- 1 page hole (up to 32 pages).
- 165 mm x 95 mm.
- Full colour.
- Laminated covers.
- Stitched booklet on short or long edge.

CGSSSE3D

3D GRAPHICS - WIRO BINDED AND ROUND CORNERS BOOKLET

- 1 page hole (up to 32 pages).
- 165 mm x 95 mm.
- Full colour.
- Laminated covers.
- Stitched booklet on short or long edge.

CGWIRO3D

ADDITIONAL OPTIONS (PRICE PER BOOKLET)

Wiro Binding	CGWIROSTAP
Embossing	CGEMBOSS
Spot UV	CGSPOTUV
Foil	CGFOIL

Price per booklet include design, set-up, proofing and surveying (tee to green).

All prices are subject to final confirmation once all requirements are known.

- SCORE CARDS -

STANDARD 4 PAGE - SINGLE FOLD - SCORE CARD

- Standard size score cards.
- 134 mm x 80 mm per panel.

SC4PP

OVERSIZED 4 PAGE - SINGLE FOLD - SCORE CARD

- Oversized size score cards.
- 145 mm x 100 mm per panel.
- Price for 2,000 pcs.

SC4PPOS

STANDARD 6 PAGE - DOUBLE FOLD - SCORE CARD

- Standard size score cards.
- 134 mm x 80 mm per panel.
- Price for 2,000 pcs.

SC6PP

OVERSIZED 6 PAGE - DOUBLE FOLD - SCORE CARD

- Oversized size score cards.
- 145 mm x 100 mm per panel.
- Minimum order quantity: 5,000 pcs.

SC6PPOS

ADDITIONAL OPTION (COSTS PER ORDER)

- Round corners 4 page score card **SC4PPRC**
- Round corners 6 page score card **SC6PPRC**

LANDSCAPE FOLD- SCORE CARD

- Landscape fold score cards.
- 160 mm x 95 mm per panel.
- With rounded corners as standard.

SCLSRC



Prices include design, set-up, proofing and surveying (tee to green).
All prices are subject to final confirmation once all requirements are known.

- MAINTENANCE -

TEAK MAINTENANCE

Teak wood, like any other wood, is a natural material and will react to the effects of the natural changes of the weather and the exposure to direct sunlight. Please find below a brief description of the natural colour and surface change of any teakwood product.

If untreated, teak wood will turn 'grey'. Also a natural product will 'work' and the grains of the wood will open slightly due to the effects of the weather. Most people find the natural grey colour the 'charm' of the product. A yearly treat with (very fine) sandpaper can be done to keep the surface smooth.

Teak wood can be treated to keep the colour more like the light, more brown, colour. It then needs to be oiled with Teakoil and should be treated every 3-4 months for maximum preservation of the wood or could even be laquered in any colour you may wish. Do not hesitate to contact us should you need more information regarding preservation of teak wood.

TECHNOWOOD MAINTENANCE

Technowood is a 'zero maintenance' product – it may need cleaning every once in a while; for this use a damp soft cloth – do not use soaps or anything else, just wipe it down and let it dry. It is as simple as that.

Technowood has a colour guarantee of 10 years and a life expectancy of 30 years!

HARDWOOD / IROKO MAINTENANCE

Unfinished product

All timber products will retain a certain amount of moisture content, therefore some crazing or minor surface checking may occur soon after installation.

This movement is totally natural and beyond our control. Any movement that may occur is usually confined to the first year and in no way affects the suitability of the wood. Maintenance of untreated hardwood is the same as for Teakwood – see above.

Finished product: Finishing Process

The timbers are initially treated with Teknos Aquatop 2900 base coat stain. Once dry, the end grains are sealed to ensure maximum protection against moisture ingress. Finally, two topcoats of Teknos Aquatop 2600 are applied to achieve the maximum level of protection and colour.

After Installation

It is essential that all timber products be wiped down after any application of fertilisers or chemicals onto the course. Nitrogen based fertilisers, in particular, can burn through the protective coating in a matter of hours.

Maintenance Guidelines

The initial coating from our factory should last a minimum 12 months, however this is dependent on the location of the sign, specifically relating exposure to moisture, fluctuations in temperature, prevailing winds and excessive weather. - the only other maintenance required during this period is to keep the sign clean.

Ideally monthly, but at least once per year, all coatings should be washed with mild detergent and water to remove any surface marks, whilst being assessed for any damage or degradation that may require treatment.

In all cases, timber products should be checked periodically for 'damage', wear and tear. If the surface coating displays any damage, this will accelerate moisture ingress through the surface and subsequently cause possible degradation of the affected area.

If touching up or full repainting is required, a coating of Teknos Aquatop 2600 is preferred however a good quality proprietary external grade paint finish is acceptable. (Available from your local DIY store). If applied annually, the frames will continue to look good and perform as required.

Limitations

Local ground & climate conditions can vary greatly and must be considered by the installer for the effects on timber products. This information sheet is for general guidance only and all installations are the direct responsibility of the club or installer. No responsibility or liability can be accepted.



- SIGNAGE -



FINGER POST - TECHNOWOOD

- Made of UV resistant, maintenance free Technowood.
- Full 10 year colour retention guarantee.
- Available in 2 sizes: 120 cm & 180 cm.

Technowood finger post 120cm Brown	P78410
Technowood finger post 180cm Brown	P78411
Technowood finger post 120cm Green	P78412
Technowood finger post 180cm Green	P78413
Technowood finger post 120cm White	P78414
Technowood finger post 180cm White	P78415

FINGER POST - TECHNOWOOD ARROWS

- All Arrows including double sided signage.

Technowood finger post arrow Brown	P78421
Technowood finger post arrow Green	P78422
Technowood finger post arrow White	P78423

Optional Ground anchor **P78424**



FINGER POST - TEAK ARROWS

Finger post **DU82326**
 • Post only.
 • Size: 250 x 10 x 10 cm.

Finger teak straight **DU82327**
 • Including double sided signage.

Finger teak 45° **DU82328**
 • Including double sided signage.



FINGER POST - PLASTIC ARROWS

- Powder coated aluminium post.
- Multiple arrow possibilities at any angle.

Direction arrow hunter green **DU82500**
 • Incl. text, maximum 15 letters.

Aluminium post 260 cm **DU82501**
 Pipe cap **DU31002**



- SIGNAGE -

CAST MOW-OVER TEE PLAQUES

- Made by using a revolutionary technology that 'fuses' metal to high density urethane.
- Process uses less metal, less energy and eliminates virtually all toxic emissions into the air.
- Look, feel and perform like a foundry-poured sign but without the weight and the high production costs.
- Available in multiple sizes and shapes. Do ask for a custom quote.
- Custom logo at no extra cost.

Cast mow-over Ø 15 cm aluminium **DU34200**
 Cast mow-over Ø 15 cm bronze/ copper **DU34201**

Cast mow-over Ø 20 cm aluminium **DU34210**
 Cast mow-over Ø 20 cm bronze/ copper **DU34211**

Cast mow-over Ø 25 cm aluminium **DU34220**
 Cast mow-over Ø 25 cm bronze/ copper **DU34221**



ROUND MOW-OVER SIGN

- Provides a subtle and stylish marker.
- Available with superb natural granite or cast bronze plaques.
- Can also be used for creating an official fairway to green distance marker.
- Size: Ø 23,2 cm.

Mow-over black cast granite Ø 23,2 cm **PMOW1CG**

Mow-over granite Ø 23,2 cm **PMOW1NG**

Circular plinth Ø 32,5 cm with 23,5 cm recess **PMOWP**



PAR 3 DISTANCE SIGN

- Give golfers exact distance to the hole on par 3's with this sign.
- Place it in the cart path, near the bottom of a hill or right next to your tee markers.
- Size: 26 cm x 14 cm x 2 cm.

Sign Only **PA5380**

Replacement back panel (2-pack) **PA5381**

Numbers sold in packs of 4:

"0" PA5380-0	"5" PA5380-5
"1" PA5380-1	"6" PA5380-6
"2" PA5380-2	"7" PA5380-7
"3" PA5380-3	"8" PA5380-8
"4" PA5380-4	"9" PA5380-9



- TEE SIGNS -



TECHNOWOOD TEE SIGNS

The new Technowood is a product similar to wood but does not present the limitations of the wood itself; it is made out of recycled PVC & Fiberglass and finished with a surface film giving a full 10 year warranty on colour retention and an estimated life of 30 years! No maintenance required at all and endless product possibilities.



The main advantages:

- Impact and pressure resistant.
- Resistant to water, humidity, heat and frost.
- UV resistant with a full 10 year colour retention guarantee.
- Absolutely maintenance free.
- Workability and fixing such as wood.
- Estimated lifetime of 30 years.
- Including sign.

TECHNOWOOD TEE SIGN TWEED

- | | |
|-------|---------------|
| Brown | P78510 |
| Green | P78511 |
| White | P78514 |

TECHNOWOOD TEE SIGN LEVEN

- | | |
|-------|---------------|
| Brown | P78512 |
| Green | P78513 |
| White | P78515 |

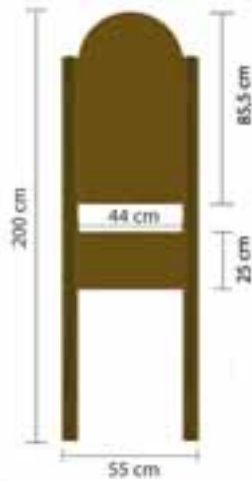

*Teesign Technowood
Tweed Brown*

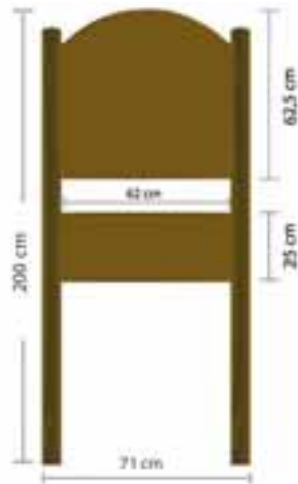

Teesign Technowood Leven Brown

- TEE SIGNS -



Tee signs can also be used for general information and routing purposes.

TEE SIGN PADDINGTON

- Made from teak wood.
- Including full colour hole layout.
- Excluding artwork.
- Size: 160 x 80 x 8 cm.

DU82347

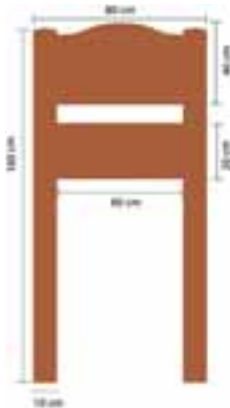

THE DUTCH TEE SIGN

- Made from teak wood.
- Including etched aluminium plates.
- Size: 55 x 12 x 12 cm.

DU82406



- BALL WASHERS -



THE PAR AIDE BALL WASHER

Far and away, Par Aide

No matter which Par Aide model you choose, your decision won't be challenged.

A Par Aide ball washer says golf. It says you care about quality. It tells golfers this superintendent is conscious of all the details that make a course enjoyable to play.

- Hand assembled from the highest-quality materials.
- Powder-coated cast aluminium body and cover, stainless steel hardware, nylon bristles set in rubber for durability.
- Patented helical agitator assures thorough cleaning and dependability.
- Improved integrity of powder coating because of a new pre-treatment process and the use of foam rubber gaskets between cover and body.



DELUXE BALL WASHER

Our most popular model. Drain plug located in front for easy cleaning and flushing. Patented internal overflow sends excess liquid down the inside of the pipe stand.

- Capacity: 3,3 litres.
- Weight: 4,5 kg.

- | | |
|-------------------------------|-----------------|
| Par Aide Red | PA203-01 |
| Hunter Green | PA203-02 |
| Black | PA203-00 |
| Other colours, please specify | PA203-99 |

Use with ball washer detergent.
See page 81.

Optional colours

Custom

Hunter Green	Par Aide Red	Par Aide Black	Par Aide Yellow	Par Aide White	Imperial Blue	Par Aide Blue	Industry Brown	Camel Beige	Any Colour

- BALL WASHERS -



MASTER BALL WASHER

The classic, original design.

- Capacity: 2,4 litres.
- Weight: 4,05 kg.

Par Aide Red	<i>PA205-01</i>
Hunter Green	<i>PA205-02</i>
Black	<i>PA205-00</i>
Other colours, please specify	<i>PA205-99</i>

PAR AIDE BALL WASHERS OFFER:

- One moving part; easy to maintain and replace.
Unit can be completely flushed and cleaned by removing only two coated, stainless steel set screws.
- Tamper-resistant drain plug with gasket eliminates any chance of leaking.
- Aluminium castings allow for unlimited colour options and unmatched durability.
- Known and preferred by golfers over the world.

RECOMMENDED MAINTENANCE:

- For effective cleaning, use Ball Washer Detergent.
- Regularly refill and change water.
- Touch-up paint as needed (see page 81).



- BALL WASHER ENSEMBLES -



These are a few of the ensembles created to make ordering easy for you. With all of these options, you can place your ensemble design where it's most needed. You may opt to put an ensemble with a club washer on the tee of a par 3 hole, for instance, or one with a Trash Mate® double unit on the tee following the halfway house. Just start with the combination you like and pick a colour. If you don't see the combination you are looking for, simply mix and match by choosing the individual items that best fit your situation.



MASTER ENSEMBLE

Par Aide Red **PA50-01**
 Hunter Green **PA50-02**
 Black **PA50-00**
 Other colours,
 please specify **PA50-99**



**MASTER ENSEMBLE WITH TRASH MATE®
 SINGLE UNIT**

Par Aide Red **PA51-01**
 Hunter Green **PA51-02**
 Black **PA51-00**
 Other colours,
 please specify **PA51-99**



**MASTER ENSEMBLE WITH TRASH MATE®
 DOUBLE UNIT**

Par Aide Red **PA52-01**
 Hunter Green **PA52-02**
 Black **PA52-00**
 Other colours,
 please specify **PA52-99**

Towels (not included on above models) may be purchased separately (see page 113).

- BALL WASHER ENSEMBLES -



Optional Colours

Custom



Par Aide
Red

Black

Yellow

White

Imperial
Blue

Par Aide
Blue

Industry
Brown

Camel
Beige



DELUXE ENSEMBLE

Par Aide Red **PA30-01**
 Hunter Green **PA30-02**
 Black **PA30-00**
 Other colours,
 please specify **PA30-99**

**DELUXE ENSEMBLE WITH TRASH MATE®
SINGLE UNIT**

Par Aide Red **PA31-01**
 Hunter Green **PA31-02**
 Black **PA31-00**
 Other colours,
 please specify **PA31-99**

**DELUXE ENSEMBLE WITH TRASH MATE®
DOUBLE UNIT, SPIKE BRUSH AND CLUB
WASHER**

Par Aide Red **PA34-01**
 Hunter Green **PA34-02**
 Black **PA34-00**
 Other colours,
 please specify **PA34-99**

Towels (not included on above models) may be purchased separately (see page 113).

- BALL WASHER PARTS & ACCESSORIES -



1. BALL WASHER BODIES

DELUXE BODY

- Weight: 2,7 kg.

Par Aide Red	PA1203-01
Hunter Green	PA1203-02
Other colours*	PA1203-99

MASTER BODY

- Weight: 1,8 kg.

Par Aide Red	PA1205-01
Hunter Green	PA1205-02
Other colours*	PA1205-99

2. BALL WASHER COVERS

DELUXE COVER

- Weight: 0,9 kg.

Par Aide Red	PA2203-01
Hunter Green	PA2203-02
Other colours*	PA2203-99

MASTER COVER

- Weight: 0,9 kg.

Par Aide Red	PA2205-01
Hunter Green	PA2205-02
Other colours*	PA2205-99

3. AGITATOR ASSEMBLY

PA200-30

- Weight: 0,45 kg.
- Includes hex nut, grommet and top knob.

4. AGITATOR TOP KNOB

PA200-31

5. CAP SCREW

PA200-21-4

- Set of 4

6. FOAM GASKET

Deluxe	PA203-25
Master	PA205-25

7. COVER LOCKING SCREW

PA203-70-6

- Set of 6

8. BRUSH ASSEMBLY

PA200-20

- Weight: 0,9 kg.

9. TOWEL CLIP

PA200-60-4

- Set of 4

10. DRAIN PLUG WITH GASKET

PA203-40-4

- Set of 4

11. DRAIN PLUG GASKET

PA203-50-10

- Set of 10

12. AGITATOR LOCK NUT

PA200-80-4

- Set of 4

13. AGITATOR RUBBER GROMMET

PA200-11-4

- Set of 4

14. BASE LOCKING SCREW (not shown)

PA204-70-6

- Set of 6

15. DRAIN PLUG WRENCH (not shown)

PA203-10-4

- Set of 4

16. ALLEN WRENCH (not shown)

PA203-16-4

- for Locking Screw

- Set of 4

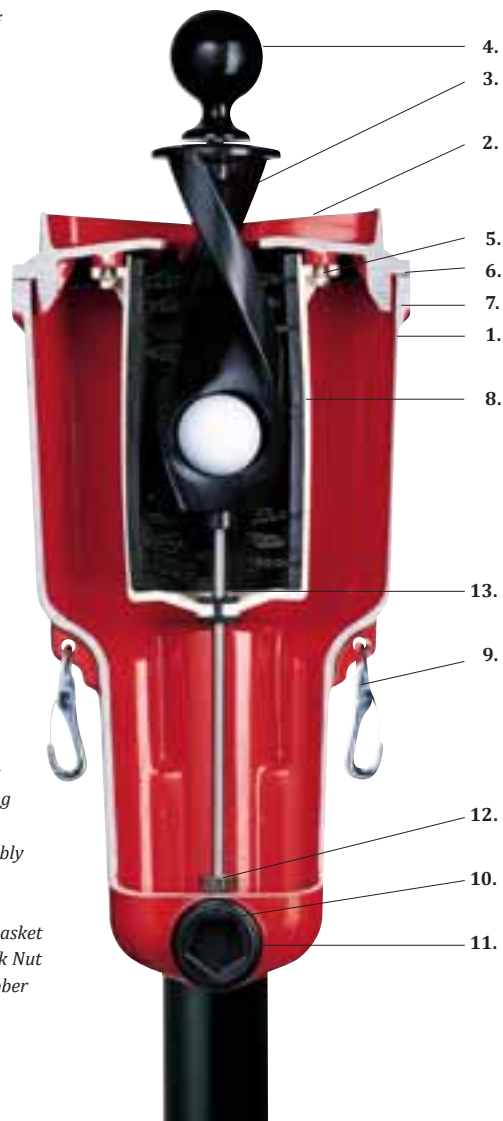

1. Body
2. Cover
3. Agitator assembly
4. Agitator Top Knob
5. Cap Screw
6. Foam gasket
7. Cover Locking Screw
8. Brush Assembly
9. Towel Clip
10. Drain Plug
11. Drain Plug Gasket
12. Agitator Lock Nut
13. Agitator Rubber Grommet

*Please specify colour

- BALL WASHER ACCESSORIES -



MOUNTING PIPE

- Lightweight, no-rust aluminium pipe for your ball washer installation.
- Powder-coated black finish.
- Size: Ø 6 cm.
- Use 87 cm with a Portable Base, 122 cm for in-ground installation.



Mounting Pipe 31 cm	PA209-00
Mounting Pipe 61 cm	PA212-00
Mounting Pipe 87 cm	PA210-00
Mounting Pipe 122 cm	PA211-00
Mounting Pipe Cap	DU31002

TOUCH-UP PAINT

- Matches the three Par Aide colours below.
- Adjustable fan spray can for expert results.

Gloss Black	PA1310-00
Par Aide Red	PA1310-01
Hunter Green	PA1310-02



BALL WASHER DETERGENT TABLETS

- Lemon-scented, non sudsing formula.
- Use one or 2 tablets with each clean and fill servicing.
- Large tablets provide a longer lasting cleaning solution.
- Eliminates the need for measuring proper amount.

Detergent tablets, jar of 2,27 kg	PA4102
Detergent tablets, case of 4 jars	PA4103



BALL WASHER LIQUID DETERGENT

- Lemon-scented, non sudsing concentrate formulated with antibacterial and odor-control agent.
- Less than 0,03 ltr. is all that is needed per clean and fill.
- Won't damage internal parts.

Liquid ball washer detergent, per 3,7 ltr	PA4110
Liquid ball washer detergent, case of 4	PA4112



BALL WASHER BRACKET

- Powder-coated black, aluminium bracket used to mount Master and Deluxe Ball Washers to any vertical flat surface 7,6 cm or wider.
- Weight: 0,45 kg

Ball washer bracket	PA215-00
---------------------	-----------------



- BALL WASHERS -

**STANDARD
GOLF** COMPANY



The PREMIER

Use with ball washer detergent.
See page 81.

TRADITIONAL SERIES BALL WASHERS

- Solid cast aluminium construction with powder-coated finish.
- Stainless steel hardware.
- Quickly clean single ball with spiral plunger action.
- The plunger is the only moving part, so maintenance is a snap.
- Plunger knob is easily replaceable if damaged.
- Give years of dependable, low-maintenance performance.

THE PREMIER

The larger of the aluminium Standard Golf ball washers, the Premier has an internal overflow and a large drain for easy maintenance. The Premier's cast aluminium construction will keep its bright colours and good looks for years to come.

- 3,3 litres washer fluid capacity.
- Mounts over post.

Red	SG01425
Green	SG01450
Black	SG01470



The MEDALIST

THE MEDALIST

The Medalist is economical, easy to use and maintain and it will be a favourite with your players too. It will last for years and still look great.

- 2,4 litres washer fluid capacity.
- Mounts inside post.

Red	SG01525
Green	SG01550
Black	SG01570

- BALL WASHERS -



CLASSIC BALL WASHER

- Wash up to four balls at once in our feature-packed, affordable priced Classic ball washer.
- Built rugged inside and out, it will look good and perform well for many years.
- Fast, no-splash crank operation.
- Overflow tube prevents leaks and soap built-up.
- Weight: 2,7 kg.



Yellow
SG01300



Red
SG01325



Green
SG01350



Blue
SG01375



INSTALLATION

- Order as part or a complete tee console with Tripod stand (SG36200) and Litter Caddie (see page 110).
- Attach to a mounting pipe for in-ground installation.

JUNIOR CONSOLE

The junior console is one of the most popular models and for good reason. Check out these features:

- Wide-stance tripod-style stand combines simplicity, utility, affordability; and it's built to last.
- Very portable. Easy to move around to minimize wear and tear in high-traffic areas.
- Screw-in spikes (included) anchor it firmly into the ground.
- Includes Junior Console Stand (Black) with a Classic Ball Washer and a colour matched 34 litre litter Caddie with spike.

JUNIOR CONSOLE WITH CLASSIC BALL WASHER

Red	SG39825
Green	SG39850
Black	SG39870



- BALL WASHER PARTS -

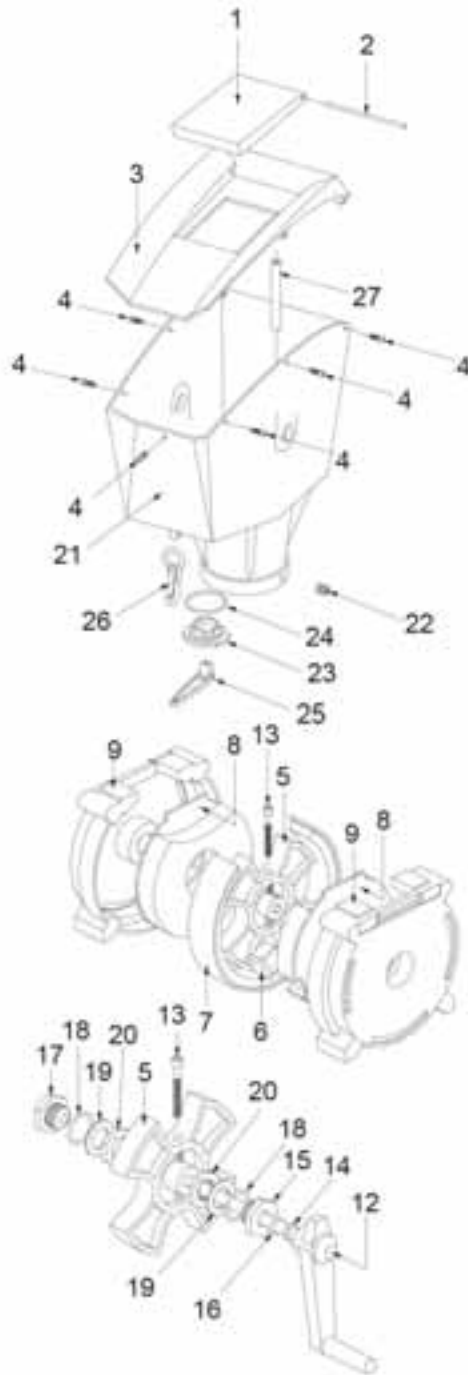

PARTS CLASSIC BALL WASHER

SG01300, SG01325, SG01340, SG01350, SG01370, SG01375, SG01395

- | | |
|-----------------------------------------------------------------|----------------|
| 1. BALL WASHER LID | SG01303 |
| 2. HINGE PIN | SG01314 |
| 3. TOP | SG01302 |
| 4. 6 X 3/8" PHILLIPS PAN HEAD TRI-PLASK SCREW | SG01313 |
| 5. IMPELLER | SG01342 |
| 6. RUBBER BUMPER | SG01323 |
| 7. RACE BRUSH | SG01348 |
| 8. SIDE BRUSH | SG01347 |
| 9. CARTRIDGE HALVES | SG01321 |
| 12. CRANK | SG01344 |
| 13. 10-24 X 1-1/2" STAINLESS STEEL SOCKET HEAD CAP SCREW | SG01346 |
| 14. RETAINING PLUG | SG01311 |
| 15. OPEN END BEARING | |
| <i>(is included with the SG01311)</i> | |
| 16. CRANK O-RING | |
| <i>(is included with the SG01311)</i> | |
| 17. BLIND END BEARING | SG01318 |
| 18. BEARING O-RING | SG01331 |
| 19. FIBER GASKET | SG01332 |
| 20. PLASTIC LOCKNUT | SG01333 |
| 21. CASE | |
| Case - Yellow | SG01301 |
| Case - Red | SG01326 |
| Case - Brown | SG01341 |
| Case - Green | SG01351 |
| Case - Black | SG01371 |
| Case - Blue | SG01376 |
| Case - White | SG01396 |
| 22. 5/16 X 1/2" STAINLESS STEEL SET SCREW | SG01317 |
| 23. DRAIN PLUG | SG01328 |
| 24. DRAIN PLUG GASKET | SG01327 |
| 25. DRAIN PLUG WRENCH | SG01306 |
| 26. TOWEL SNAP | SG01320 |
| 27. OVERFLOW TUBE | SG01352 |

- CLUB WASHERS & PARTS -

TECHNOBROSS ULTRASONIC CLUB CLEANER

- Ultrasonic cleaning uses cavitation bubbles induced by high frequency (sound) waves to agitate a liquid.
- Is commonly used to clean jewelry and medical instruments.
- Gives an amazing result on on club heads & grips. Clean a batch of up to 12 clubs in only a few minutes.
- Gives a great service to the members.
- Can be equiped with a token or coin mechanism on request.
- Simple to operate, easy to empty.
- Compact and mobile unit.
- Size: Width: 82 cm, Depth: 76 cm, Height: 105 cm.



Technobross Ultrasonic Club Cleaner **DU49462**

ROUND CLUB WASHER

- Made of weatherproof recycled plastic with pointed slats for secure anchoring in turf.
- Interior bucket has attached brushed that clean club effectively.
- Size: Ø 36 cm, Height: 46 cm.

Black **MT692270**
 Brown **MT692271**
 Green **MT692272**

Club washer replacement brush, per pc **MT692270-1**



CLUB WASHER COMPLETE

- Capacity: 1,66 litre.
- Weight: 1,35 kg.

Red **PA250-01**
 Hunter Green **PA250-02**
 Black **PA250-00**

Replacement brushes, set of 2 **PA254**



RANGE MATE CLUB WASHER

- Gentle, no-splash brushes will handle woods and irons.
- Efficient, effective design with replaceable brushes.
- Large-capacity, fade-resistant 34 litre polyethylene containers, reinforced with steel frame.
- New square opening allows easier access to clean clubs.
- Available in Hunter Green.
- Comes with floorstand.

Range mate clubwasher, Hunter Green **SG01650**
 Replacement brush for Range Mate (p/pce) **SG01602**



- CLUB WASHER PARTS -



MOUNTING PIPE 30,5 CM

- For use with portable base.
- Weight: 0,45 kg.

PA209-00



OPTIONAL MOUNTING BRACKET

- Mounts a club washer to any 5,1 cm pipe or any flat surface 15,2 cm or wider.
- Hardware included.
- Weight: 0,45 kg.

PA275



SINGLE SPIKE MOUNTING KIT

- Bolts to bottom of club washer, and moves as easily as a tee marker.
- Hardware included.
- Weight: 0,45 kg.

PA260



BALL WASHER REPLACEMENT KIT

- Everything you need for refurbish.
- Foam gaskets for covers included but not shown.
- For the Par Aide Master and Deluxe ball washer models.
- Weight: 1,35 kg.

PA200-10

- TEE MARKERS -



PINE TEE MARKER

- Made from durable resin.
- Very natural look.
- Ends slanted for more visibility.
- With two steel spikes.
- Size: 20 x 10 cm.
- Weight: 1,3 kg.

White	DU34024
Yellow	DU34025
Red	DU34026
Blue	DU34027
Black	DU34028
Orange	DU34029



AUGUSTA TEE MARKER

- Teak tee marker.
- Blends in well with surroundings.
- Size: 25 cm.
- Comes with two zinc plated 16 cm spikes.
- Carton: 6 pieces.

Red	DU34001
White	DU34002
Blue	DU34003
Yellow	DU34004
Black	DU34005
Orange	DU34006



TEAK TEE MARKER SQUARE

- Made from teak wood.
- For a real classic look.
- With stainless steel spike.
- Size: 15 x 10 x 10 cm.
- Banded vinyl colour.

DU82329

Please state colour.



PATISSON DIMPLE TEE MARKER FLAT

- Made from durable solid resin.
- Nearly unbreakable.
- Stainless steel 10 cm spike.
- Weight: 0,38 kg.
- Diameter: 15 cm.

White	P407115W
Yellow	P407115Y
Red	P407115R
Blue	P407115B
Black	P407115BL
Orange	P407115O



- TEE MARKERS -



DIMPLE-T MARKERS

- The popular line of Dimple-T Markers is available in just about every colour you can imagine.
- Choose from two eye-catching styles: classically plain or personalised with your club logo and / or hole number.
- Made of space age polymers with molded-in galvanised steel spike.
- Size: Ø 13 cm.
- Weight: 0,35 kg.
- Carton: 18 pieces.

PLAIN DIMPLE-T MARKERS

Red **CA16361**
 White **CA16362**
 Blue **CA16363**
 Yellow **CA16364**
 Black **CA16365**

PERSONALISED DIMPLE-T MARKERS

CA16381
CA16382
CA16383
CA16384
CA16385

Silver **CA16366**
 Gold **CA16367**
 Orange **CA16368**
 Green **CA16360**
 Pink **CA16371**

CA16386
CA16387
CA16388
CA16380



PERSONALISE YOUR MARKERS

Colourful, personalised or numbered decals can be supplied, but they must be ordered separately.

Decal size: Ø 7 cm.

Sticker for personalised Dimple-T up to 18 pieces

Sticker for personalised Dimple-T 19-36 pieces

Sticker for personalised Dimple-T 37+ pieces

STICKERDP1

STICKERDP2

STICKERDP3

STICKER SETS OF NUMBERS FOR DIMPLE TEE MARKERS

- Set of 9 includes two of each number.

Set 1-9, *Please state colour* **CA31652**

Set 10-18, *Please state colour* **CA31651**



CAST TEE MARKERS

- Made by using a revolutionary technology that 'fuses' metal to high density urethane.
- Process uses less metal, less energy and eliminates virtually all toxic emissions into the air.
- Look, feel and perform like a foundry-poured sign but without the weight and the high production costs.
- Available in multiple sizes and shapes. Do ask for a custom quote.
- Custom logo at no extra cost.

Cast Tee Marker Ø 15 cm round aluminium

DU34300

Cast Tee Marker Ø 15 cm round bronze or copper

DU34301

- TEE MARKERS -



*With neck
without engraving.*



*With neck and
engraving.*



*Without neck, and
engraving.*

FORE-EVER MARKED TEE MARKER

- Made from a special blend of resins.
- Incredibly durable with a mirrored finish.
- Size Ø: 7,6 cm , 10,2 cm, 12,7 cm.
- Comes with or without neck.
- Fitted with stainless steel spike.
- One colour engraved custom logo available on request.
- Please ask us for a quote and delivery time for engraving.

WITH NECK	7,6 CM	10,2 CM	12,7 CM
Red	MT635301	MT635401	MT635501
White	MT635302	MT635402	MT635502
Blue	MT635303	MT635403	MT635503
Yellow	MT635304	MT635404	MT635504
Black	MT635305	MT635405	MT635505
Orange	MT635307	MT635407	MT635507
Custom colour	MT635310	MT635410	MT635510

WITHOUT NECK	7,6 CM	10,2 CM	12,7 CM
Red	MT635331	MT635431	MT635531
White	MT635332	MT635432	MT635532
Blue	MT635333	MT635433	MT635533
Yellow	MT635334	MT635434	MT635534
Black	MT635335	MT635435	MT635535
Orange	MT635337	MT635437	MT635537
Custom colour	MT635340	MT635440	MT635540

SPHERICAL PLASTIC TEE MARKER

- One of the most economical markers. Features welded, 2-piece construction with cast-in stainless steel spike attached.
- Size: Ø 10 cm.

White	PA640-2
Yellow	PA640-4
Red	PA640-1
Blue	PA640-3
Black	PA640-5



- BROKEN TEE CADDIES -



BELL BROKEN TEE CADDY ALUMINIUM

- Made of top grade cast aluminium with powder coated finish.
- Comes with stainless steel spike and broken tee decal.
- Size: 10 cm high and Ø 13 cm.
- Weight: 0,45 kg.

Black	DU18000
Yellow	DU18015
Red	DU18025
Green	DU18050
Blue	DU18075
White	DU18095
Orange	DU18096



BROKEN TEE BOX

- Sits directly on the ground. Legs allow for air flow.
- Fade- and rust-resistant and maintenance-free.
- Powder-coated expanded metal bottom.
- Size: 20 x 25 x 9 cm.

Hunter Green	PA3490
Black	PA3491
Redwood	PA3492
Caramel	PA3493



Colours: Hunter Green, Black, Redwood & Caramel



- BROKEN TEE CADDIES -



BROKEN TEE CADDY STEEL

- To get rid of the nuisance of broken tees.
- Keep your tee surface clean and organised.
- Made of powder-coated steel and separate spike.
- Cover with hole and text: TEES ONLY optional.
- Size: 15 cm high and Ø 13 cm.
- Weight: 0,34 kg.
- Packed per 3.

Black	CA20111
Yellow	CA20126
Red	CA20136
Green	CA20161
Blue	CA20186
White	CA20106



BROKEN TEE CADDY PLASTIC

- Keep your tee surface free from broken tees.
- Made of plastic with integrated thread for steel spike.
- Cover with hole and text: TEES ONLY optional.
- Size: 15 cm, Ø 13 cm.
- Weight: 0,4 kg.
- Carton: 9 pieces.

Black	PC19000
Yellow	PC19015
Red	PC19025
Green	PC19050
Blue	PC19075
White	PC19095
Orange	PC19096



BROKEN TEE CADDY COVER

- Cover with hole and text: TEES ONLY.
- For plastic and steel broken tee caddy.

PC19100



- COMPETITION MARKERS -

Place a contest indicator on the tee to announce the contest on that hole.
The proximity marker goes in the fairway or green to mark the longest drive, closest to the pin or other contest.

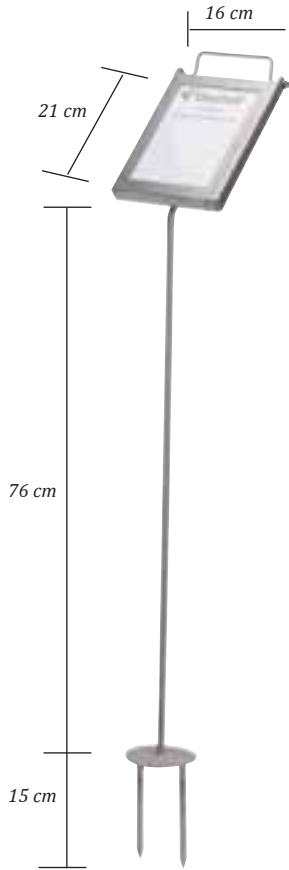

STAINLESS STEEL CONTEST INDICATOR, MESSAGE HOLDER OR LONGEST DRIVE INDICATOR

- A classy and durable solution for any message you would like to put on the tee.
- Made of stainless steel.
- Holds 20 x 15 cm cards (not included).

Stainless steel indicator holder **PC19210**



Hinged lid provides easy access to message card.



PROXIMITY MARKER AND CONTEST INDICATOR

- Paper-free proximity marker includes an attached grease pen, contest indicator, unattached grease pen.
- Choose stock design, or customize with course or event logo (price on request).
- Cleanup: Wipe with a clean towel, any household cleaner helps.
- Reusable, rainproof Polycarbonate surface eliminates paper sheets.

Contest indicator **PA10602**
Proximity marker **PA10600**

REPLACEMENT PARTS (NOT SHOWN)

Replacement pen with Velcro **PA10690**
Tube of 6 replacement leads **PA10691**



Contest indicator



Proximity marker

SUPER TIP: Spray surface with WD40 for easy cleaning.

- COMPETITION MARKERS -

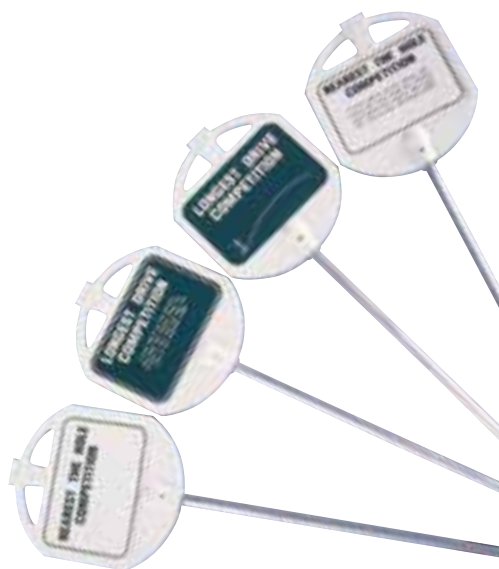

CAST ALU CONTEST INDICATOR AND PROXIMITY MARKER

- Made in cast aluminium for that traditional look.
- Each set comes complete with card holder and cards.

Indicator Nearest to the Hole	PCA602-01
Indicator Longest Drive	PCA602-02
Proximity Marker Nearest to the Hole	PCA602-03
<i>Card holder with cards on the back</i>	
Proximity Marker Longest Drive	PCA602-04
<i>Card holder with cards on the back</i>	

COMPLETE SET

PCA602-01, -02, -03, -04	PCA602
Replacement cards (50 pcs.)	PC19203



PLASTIC CONTEST INDICATOR AND PROXIMITY MARKER

- White plastic marker head.
- Aluminium spike.
- Proximity markers are including card holder and cards.



Plastic contest Indicator Nearest	PC19200
Plastic contest Indicator Longest Drive	PC19201
Plastic contest Proximity Marker Nearest	PC19204
<i>Card holder with cards on the back</i>	
Plastic contest Proximity Marker Longest Drive	PC19205
<i>Card holder with cards on the back</i>	

Replacement cards (50 pcs.)	PC19203
-----------------------------	----------------

PROXIMITY MARKERS

- Easy-to-read.
- Four markers with pencil holders.
- Four packs of double-sided cards (25 each) printed with Long Drive on one side and Proximity on the other.
- Size: 66 cm tall, pad area is 20,3 cm x 12,7 cm..



Set of four markers	SG10700
Replacement cards (25 pcs.)	SG10701



- DISTANCE MARKERS -



TEAK DISTANCE POSTS

- Made from teak wood.
- Size: 100 x 5 x 5 cm.

Post 100	<i>DU82320</i>
Post 150	<i>DU82321</i>
Post 200	<i>DU82322</i>



PROPLEX DISTANCE MARKER

- Proplex distance post – great looking – great visibility – no maintenance!
- Recycled plastic distance post.
- Maintenance free.
- Complete with Aluminium ground socket.
- Total post dimensions: 75 x 5 x 5 cm.
- Goes around 20 cm into the ground.
- Colour black – on request available in other colours.

Post 100	<i>PFW-300-B100</i>
Post 150	<i>PFW-300-B150</i>
Post 200	<i>PFW-300-B200</i>



INDIVIDUAL PVC DISTANCE MARKERS (INCLUDING CAP AND DECAL)

- For a sharp, more visible look.
- 18 cm PVC ground anchors make the markers easy to remove and replace. (not included)
- Includes cap and decal.
- Height: 81 cm.
- Weight: 0,37 kg.

White with red 100 decal	<i>SG09310</i>
White with black 150 decal	<i>SG09320</i>
White with blue 200 decal	<i>SG09330</i>
White with yellow 250 decal	<i>SG09340</i>
Yellow with black 150 decal	<i>SG09350</i>

PVC ground anchor	<i>SG16157</i>
Driving tool	<i>SG16158</i>

- DISTANCE MARKERS -



RECYCLED RUBBER TEE DISTANCE MARKERS

These colourful, recycled rubber markers are perfect for marking the exact tee to green distance.

- Made from recycled tires.
- UV resistant.
- Colours coordinate with tee markers.
- Will not rust, chip or damage mowers and trimmers.
- With 14 cm steel spike.
- Weight: 1,4 kg.
- Height: 2,9 cm.
- Size Ø: 20 or 28 cm.
- Carton: 10 pieces.



	Ø 20 cm	Ø 28 cm
Red	CA10111	CA10161
White	CA10112	CA10162
Blue	CA10113	CA10163
Yellow	CA10114	CA10164
Black	CA10116	CA10166

STEEL DISTANCE MARKER

- Helps players to judge distances to the green.
- Brightly coloured powder coated marker.
- With 24 cm spike.
- Size Ø: 30 cm.
- Carton: 7 pieces.

Red	CA10311
White	CA10312
Blue	CA10313
Yellow	CA10314



TUMMY STEEL MARKER

- Helps players to judge distances to the green.
- Can be used as tee-, fairway- or hazardmarker.
- Size Ø: 15 cm.

Red	DU34080
White	DU34081
Blue	DU34082
Yellow	DU34083
Orange	DU34084
Purple	DU34085



- DISTANCE MARKERS -



ALUMINIUM DISTANCE MARKER

This beautiful shaped marker is available in aluminium in the colour green with an UV protecting lacquer.

- Aluminium powder coated marker.
- 1 stripe: 100 mtr, 2 stripes: 150 mtr, 3 stripes: 200 mtr.
- Height: 85 cm / Ø: 6 cm.
- Order ground anchor separately.

ALUMINIUM MARKER

Aluminium Marker* **DU49209**

Synthetic ground anchor **DU49216**

Driving tool **SG16158**

**Please specify the number of rings*



LAMINATED FAIRWAY DISTANCE MARKERS

- Dependable and economical yardage marker for your course.
- The Ø 28 cm marker features routed numbers.
- Reliable and weather-resistant.
- Includes stainless steel spike to secure the marker.

	Ø 15 cm		Ø 28 cm
Red	PA5330	Red 100	PA5300
White	PA5331	White 150	PA5301
Blue	PA5332	White 200	PA5303
Black	PA5333	Blue 200	PA5304
Yellow	PA5334	Blue 250	PA5305
		Black 250	PA5306
		Yellow 150	PA5307

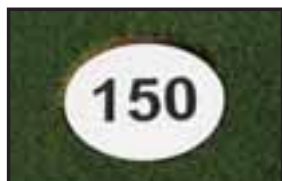

THE KIRBY MARKER SYSTEM

- Complete line of fairway and tee distance markers.
- Because they are above the turf (but can be driven right over) they are visible from any direction.
- Choose the complete Kirby marker system that 1.000 courses throughout the world use to speed up play, build revenue and increase golfer satisfaction.

STANDARD KIRBY MARKERS

Red **DU34030**

White **DU34031**

Yellow **DU34032**

Blue **DU34036**

Please state distance.



- DISTANCE MARKERS -

SPEED AND QUALITY OF PLAY...GOLF AS IT SHOULD BE

You know Grund Guide for making premier yardage marking solutions. Now backed with the strength of Underhill@ distribution and product development, you can have the highest quality and most complete yardage marking systems available today and into the future.

DIFFERENT MODELS FOR DIFFERENT SPRINKLER HEADS

Perfect-fit caps engraved and colour filled for high visibility. Multiple number locations vary for lids with holes.



MODEL SPM 106 TORO

Fits: Toro 730, 750, 760, 780, 830/850S, 834S, 835S, DT34/35S. 854S. DT54/55, 860S, 880S.

- Colour caps: black, white, yellow, lavender.
- Colour numbers: white, black, yellow, red, blue, green, lavender.

SPM106-TORO

Please specify colour of caps and numbers



MODEL SPM 107 RAIN BIRD

Fits: Rain Bird E900, E950, E700, E750, E500, E550, 700, 751, 51DR.

- Colours caps: black, white, yellow, lavender.
- Colours numbers: white, black, yellow, orange, red, blue, green, lavender.

SPM107-RAIN BIRD

Please specify colour of caps and numbers



MODEL SPM 101 FIT OVER DISCS

Anodized aluminum (no paint!), these markers are engraved and custom fit to each sprinkler. Multiple number locations vary for lids with holes.

Fits: Toro 630, 650, 660, 670, 680, 690, 830/850S, 834S, 835S, DT34/35, 854S, 855S, DT54/55, 860S, 880S, Rain Bird 47/51 DR, 71/91/95, E900, E950, E700, E750, E500, E550, 1100, Hunter G-70/75, G-90/95, G-990, G-995, John Deere/Signature – Call.

- Colour tags: black, bordeaux, lavender.
- Colour numbers: grey.

SPM101-FITOVER

Please specify colour of tags and numbers



MODEL SPM 105 FIT MOST HEADS

Anodized aluminum (no paint!), these markers are engraved and custom fit to each sprinkler. Multiple number locations vary for lids with holes.

- Colour tags: black, bordeaux, lavender.
- Colour numbers: grey.

SPM105-

Please specify colour of tags and numbers



- One marking engraved on sprinkler cap **X-#1YM**
- Two markings engraved on sprinkler cap **X-#2YM**
- Three markings engraved on sprinkler cap **X-#3YM**

- DISTANCE MARKERS -

FAIRWAY - TEE - RANGE DISTANCE MARKERS

Large 17,78 cm (7 1/2") cap with big bold 7,62 cm (3 1/2") standard yardage numbers. Ideal for fairway, tee and driving range marking. Optional 20,32 cm (8") mounting pipe attachment available for secure installation.



STANDARD FAIRWAY DISC SYSTEM

Colour-coded markers with bold 7,62 cm (3 1/2") yardage number.

Several system options available.



Yellow disk with 75

UFTM-Y-75

Red disk with 100

UFTM-R-100

White disk with 150

UFTM-W-150

Blue disk with 200

UFTM-BL-200

Black disk with 250

UFTM-BK-250

ORDER SEPERATELY:

Optional 20,32 cm (8") mounting pipe (installs easily with standard cup cutter)

UFTM-PL

CUSTOM FAIRWAY DISC OPTIONS

Markers can be customized to display specific yardage numbers, include logos, or custom design.



Disk no markings

UFTM

Please state colour: Yellow, Orange, Red, White, Blue, Black, Green and Lavender.



Disk incl. one custom number

UFTM-#1

Disk incl. two custom numbers

UFTM-#2

Disk incl. three custom numbers

UFTM-#3

Logo added to disk

UFTM-LOGO

ORDER SEPERATELY:

Optional 20,32 cm (8") mounting pipe (installs easily with standard cup cutter)

UFTM-PL

DIFFERENT MODELS FOR DIFFERENT SPRINKLER HEADS

Perfect-fit caps engraved and colour filled for high visibility. Multiple number locations vary for lids with holes.



MODEL SPM 103 TORO SNAP IN

OEM UPGRADE to high quality polycarbonate custom fit. One complete, high-visibility marker snaps into OEM plug.

Fits: Toro 730, 750, 760, 780, 830/850S, 834S, DT34/35, 854S, DT54/55, 860S, 880S

Colour snap in: white, yellow and lavender

Colour numbers: white and black

SPM-103

Please specify colour of Snap In and numbers

MODEL SPM 108 TORO & HUNTER

Special engraved plastic material designed to fit into OEM lid recess.

Fits: Toro 730, 750, 760, 780, 834S, DT34/35, 854S, DT54/55, 860S, 880S and Hunter G800, G70/75B, G870, G875, G880, G885, G990, G995

Colour markers: white and yellow

Colour numbers; black



SPM108 - TORO & HUNTER

Please specify colour of caps and numbers

- TRAFFIC CONTROL -



BARRIER HOOPS - STEEL PLASTIC COATED

- Zinc passivated prior to polyester powder-coating to ensure excellent paint adhesion, reducing flaking and increase life of product.
- Improved welding technique to further improve the quality.
- Can be pushed into the ground using foot close to the loop.
- Colour: white
- Size: (H) 30 cm x (W) 61 cm x (Ø) 8 mm.
- Carton: 10 pieces.



Barrier hoop **PA07406**

PLASTIC CHAIN

- Made of UV resistant high density polyethylene.
- Helps to direct traffic in the right direction.
- Size Ø: 50 mm.

White	25 mtr.	DU39800
Red	25 mtr.	DU39801
Yellow	25 mtr.	DU39802
Black	25 mtr.	DU39803
Green	25 mtr.	DU39804
White / red	25 mtr.	DU39805
Yellow / black	25 mtr.	DU39806
Green / white	25 mtr.	DU39807



BRAIDED POLYPROPYLENE ROPE

- On 300 mtr. spools.
- Size Ø: 6,4 mm.

Yellow	PA12950
White	PA12954
Hunter green	PA12958
Hunter green / white	PA12962
Black	PA12956



- HAZARD MARKERS -



PVC HAZARD MARKERS WITH SPIKES

- Economical and easy to use.
- Virtually unbreakable.
- Caps included.
- Size: 63 cm plus 11 cm steel spike.
- Weight: 0,45 kg.
- Carton: 12 pieces.

White	CA27311
Yellow	CA27336
Red	CA27361
Blue	CA27386



TEAK HAZARD MARKERS

- Made from teak wood.
- With stainless steel spike.
- Size: 60 x 5 x 5 cm.
- Carton: 5 pieces.

DU82325
Please state colour.



RECYCLED PLASTIC ROUND HAZARD MARKERS WITH SPIKE

- Molded, UV resistant colours won't fade or chip.
- Won't absorb moisture, crack or rot.
- Size: 60 cm plus 13 cm steel spike.
- Carton: 12 pieces.

White	SG16600
Yellow	SG16625
Red	SG16650
Blue	SG16675



RECYCLED PLASTIC SQUARE HAZARD MARKERS WITH SPIKE

- Molded, UV resistant colours won't fade or chip.
- Will not absorb moisture, crack or rot.
- Size: 60 cm plus 13 cm steel spike.
- Carton: 12 pieces.

White	SG16400
Yellow	SG16425
Red	SG16450

- HAZARD MARKERS & TRAFFIC CONTROL -



Made of fully colour-impregnated recycled plastic, they need no maintenance, they are fade resistant and they float.

- Hazard and out-of-bounds markers measure 3,8 x 3,8 cm. The sturdy stainless steel spikes measure 1 cm in diameter.

HAZARD MARKERS WITH SPIKE

- Carton: 25 pieces

45 cm with spike
Red **PA11430**
Yellow **PA11433**

60 cm with spike
Red **PA11436**
Yellow **PA11439**
Blue **PA11437**

HAZARD MARKERS POINTED

- Carton: 25 pieces

60 cm pointed
Red **PA11466**
Yellow **PA11469**



OUT-OF-BOUNDS MARKERS WITH SPIKE

- Carton: 25 pieces

45 cm with spike
White **PA11618**

60 cm with spike
White **PA11620**

85 cm with spike
White **PA11623**



GREEN HAZARD MARKER END CAPS

- Easily add a green top to an existing or new hazard marker.
- Come in boxes of 25 pieces.
- Perfect fit to Par Aide hazard markers.
- Length end caps: 10 cm.

Green hazard marker end caps, box of 25 **PA11699**



GREEN & WHITE DIRECTIONAL MARKERS

- Easy to place and remove, these multipurpose markers are extremely helpful for guiding golfers in the right direction and around the course.
- Durable 20,3 cm recycled plastic white stakes with a 10,2 cm hunter green vinyl cap.
- Maintenance free.
- Sturdy stainless steel spike measures 0,8 cm in diameter.
- Versatile – direct cart and foot traffic, protect wet areas and new sod, place in front of greens etc.
- Sold only in quantities of 25, including a carrying / storage bucket.

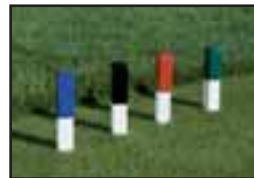

COMPLETE BUCKET OF 25 PIECES

Green & White Directional markers	PA12250-25
Red & White Directional markers	PA12251-25
Black & White Directional markers	PA12252-25
Blue & White Directional markers	PA12253-25

- TRAFFIC CONTROL -



ROPE STAKES

- Available in two colours and three sizes.
- Carton: 25 pieces

Green 30 cm **PA12200**
 Green 45 cm **PA12210**
 Green 60 cm **PA12230**

White 30 cm **PA12202**
 White 45 cm **PA12212**
 White 60 cm **PA12232**

Black 45 cm **PA12213**
 Brown 45 cm **PA12214**



Nicely shaped top.



Stainless steel spike.



DELUXE STEEL COMBO ROPE & CHAIN STAKES

- Stakes allow the user to string across either rope or chain.
- Stake measures 0,95 cm in diameter.
- With 25,4 cm spike.
- Available in three colours and two sizes.
- Carton: 12 pieces.

Yellow 63,5 cm **SG38320**
 Yellow 91,44 cm **SG38420**

Green 63,5 cm **SG38330**
 Green 91,44 cm **SG38430**

Chrome 63,5 cm **SG38310**
 Chrome 91,44 cm **SG38410**

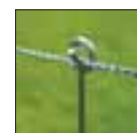
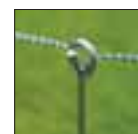
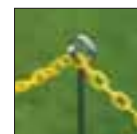

STEEL ROPE STAKES

- Stake measures 0,78 cm in diameter.
- With 14,6 cm spike.
- Positions easily with foot pressure.
- Powder coated finish for durability.
- Available in two colours and two sizes.
- Carton: 12 pieces.

Yellow 35 cm **SG37400**
 Yellow 80 cm **SG37500**

Green 35 cm **SG37450**
 Green 80 cm **SG37550**

STANDARD GOLF COMPANY

- TRAFFIC CONTROL -



**STANDARD
GOLF COMPANY**

RECYCLED PLASTIC SQUARE ROPE STAKE

- Slot designed for 0,65 cm braided rope.
- Won't absorb moisture, crack or rot.
- Available in green and black.
- With 14 cm steel spike.
- Carton: 12 pieces.

30 CM

- Green **SG37850**
- Black **SG37875**

50 CM

- Green **SG38050**
- Black **SG38075**

60 CM

- Green **SG37950**
- Black **SG37975**



TEAK ROPE STAKE

- Made from teak wood.
- Diameter: 5 cm.
- With stainless steel spike.
- Carton: 5 pieces.

- 45 cm **DU82318**
- 60 cm **DU82319**



**STANDARD
GOLF COMPANY**

RECYCLED PLASTIC ROUND ROPE STAKES

- Slot designed for 0,65 cm braided rope.
- Won't absorb moisture, crack or rot.
- Available in green.
- Diameter: 3,8 cm.
- With 14 cm steel spike.
- Carton: 12 pieces.

30 CM

- Green **SG38160**

50 CM

- Green **SG38360**

60 CM

- Green **SG38260**



TEAK CHAIN STAKE

- Made from teak wood.
- Diameter: 5 cm.
- With stainless steel spike.
- Carton: 5 pieces.

- 45 cm **DU82323**
- 60 cm **DU82324**

- DIVOT MIX CONTAINERS -



DIVOT MIX CONTAINERS

The average golfer leaves about 12 ball marks during a typical round of golf. With a daily average of 160 rounds on a typical golf course, your greens will suffer 1.920 ball marks each day and 58.400 ball marks per month equaling to more than 700.000 ball marks each year. Further, consider that the average number of divots a typical golfer creates during a round of golf is 45. This equates to 7.200 divots a day or 2.628.000 divots each year.

To empower the golfers to repair their marks it is imperative to always have the proper tools on hand: a ball-mark repair tool, topdressing material and a scoop.



DIVOT PRO TEAK

- For waste and divot repair Pattison has created unique Teak bins with solid hinged lids for easy accessibility.
- Extremely robust.
- Teak.
- Size: 53 x 37 x 37 cm.

Divot Pro

DU82302



DIVOT PRO JR.



- Recycled plastic wood slats are rustproof, fade resistant and maintenance free.
- Low profile contributes to uncluttered look on tee box.
- 18,9 litre plastic inner bin easily removable for cleaning, filling or changing.
- Weight: 6,8 kg.
- Height: 33 cm.
- Length: 48,3 cm.
- Width: 38,1 cm.

Divot pro Jr. Hunter Green

PA3420

Divot pro Jr. Black

PA3421

Divot pro Jr. Redwood

PA3422

Divot pro Jr. Caramel

PA3423

Colours:

Hunter Green, Black, Redwood & Caramel



- DIVOT MIX CONTAINERS -



DIVOT MATE

- Functionality and economy are the guiding forces behind the Divot Mate divot mix containers. They are available with different stand heights so you can choose where you position them.
- Polyethylene construction prevents denting and rusting.
- Durable frame construction, either powder coated steel or anodised aluminium.
- Large: 15 litre capacity.

DIVOT MATE CONTAINER (NO STAND)

- Includes a 10 cm spike for additional stability on the ground.
- Weight: 2,3 kg.

Black
Hunter green

PA425-00
PA425-02



HARD SURFACE STAND ONLY
PA470



LOW STAND ONLY
PA3030



WALL MOUNT BRACKET
PA475

Ground mounting spike
also available but not
shown.

GROUND MOUNTING SPIKE (4)
PA457-4

SEED AND SOIL CADDY WITH SPIKED HOLDER

- Contoured bottle keeps mixture dry.
- Steel powder-coated holder.
- 13 cm spike holds caddy firmly in place.
- Screw-on cap on bottom for easy filling.
- Decal reminds players to fill divots.
- Size: 34 x 13 cm.
- Capacity: 2,2 litre.
- Carton: 4 pieces.

STANDARD
GOLF COMPANY

Black
Green
Bottle with lid only
Lid only

SG18800
SG18900
SG18802
SG18803



- LITTER BINS -



TEAK SERIE SQUARE LITTER BIN

- Made of top quality teak wood.
- Teak wood harvested along the international regulations regarding conserving the forest by replanting trees.
- Hand-Made to get that original, traditional look.
- Maintenance-free and long lasting.
- 3 years warranty (ask for details).
- Hinged lid permits easy removal of the plastic trash can.
- Including 35 litre trash can.
- Height: 80 cm.
- Width: 44 cm.
- Length: 52 cm.

DU82316



BALL WASHER ATTACHMENT TEAK

Set of 2

DU82303



Teak ensemble with Par Aide ball washer.



Teak ensemble with Standard Golf ball washer.

- LITTER BINS -



THE TRASH MATE®

- The design and construction of the Trash Mate® receptacles reflects a thorough understanding of the golf course environment.
- Polyethylene impervious to rusting and denting.
- Capacity: 35 litre, also accepts trash bag liners.
- Windproof, snap-on lids available in three styles, all black: solid (no opening) to resist pests; trash opening; and "Cans Only" opening.
- Convenient attachment to ball washer pipe reduces number of object to be moved before mowing.
- Flexible design allows you to add a second receptacle for recycling.
- Stackable / nesting design saves storage space.



- LITTER BINS -



Double and single receptacle hardware is suitable for both wall and pipe mounting.

TRASH MATE TRASH SINGLE UNIT

- Comes with one trash opening lid and all necessary mounting hardware.
- Weight: 4 kg.



Black	PA3005-00
Red	PA3005-01
Hunter Green	PA3005-02
Blue	PA3005-03

MOUNTING PIPE



Aluminium mounting pipe 31 cm	PA209-00
Aluminium mounting pipe 61 cm	PA212-00
Aluminium mounting pipe 87 cm	PA210-00
Aluminium mounting pipe 122 cm	PA211-00
Aluminium mounting pipe cap	DU31002

TRASH MATE TRASH DOUBLE UNIT

- Includes two different lids: "Cans Only" and trash and all necessary mounting hardware.
- Weight: 7,2 kg.



Black	PA3001-00
Red	PA3001-01
Hunter Green	PA3001-02
Blue	PA3001-03

- LITTER BINS -



CONTAINER LIDS

• Weight: 0,40 kg.

Cans lid **PA3010**
 Trash lid **PA3011**
 Solid Lid **PA3012**



Cans



Solid



Trash

CONTAINERS

• Weight: 1,40 kg.

Black bottom container **PA3014-00**
 Red bottom container **PA3014-01**
 Hunter Green bottom container **PA3014-02**
 Blue bottom container **PA3014-03**



COMPLETE MOUNTING KIT **PA3019**

BACK CLAMP ONLY **PA3018**

MOUNTING BRACKET ONLY **PA3016**

HOOP FRAME ONLY **PA3015**

HARDWARE **PA3017**

Not shown



WALL MOUNT BRACKET

• For every vertical surface.
 • Weight: 0,9 kg.

Black **PA475**



LOW STAND

• Makes Trash Mate receptacles freestanding.
 • Weight: 0,9 kg.

Black **PA3030**



IN GROUND STAND

• Double spikes keeps the trash mate in place and sturdy.

Black **PA3031**

- LITTER BINS -



TRASH PRO 10

- Hinged lid permits easy removal of the 38 litre plastic can (included).
- Accepts 38 litre plastic trash can liners.
- Weight: 9 kg.
- Height: 84 cm.
- Width: 36 cm.
- Length: 46 cm.

TRASH PRO 20

- Hinged lid allows easy removal of the 76 litre plastic can (included).
- Accepts a 76 litre plastic trash can liners.
- Weight: 11 kg.
- Height: 81,3 cm.
- Width: 50,8 cm.
- Length: 50,8 cm.

Colours: Hunter Green, Black, Redwood & Caramel



Hunter Green
Black
Redwood
Caramel

Trash Pro 10

PA3820
PA3821
PA3822
PA3823

Trash Pro 20

PA3830
PA3831
PA3832
PA3833



PATTISSON TECHNOWOOD LITTER BIN

- Fixated lid to prevent blowing open.
- Hinged door for easy emptying of trash can.
- Height: 82 cm.
- Width: 45 cm.
- Length: 45 cm.
- Trash can contains 40 litre.

Hinged door for easy emptying of trash can.

Brown
Green
White

P78310
P78311
P78312



LITTER CADDIES™

- Shaped to properly contain trash contents.
- 20-gauge steel with rich, durable powder-coated finish.
- Size: 34 litre.
- Comes with a sandy soil cddie spike.



Red **SG13150**
Blue **SG13175**
Yellow **SG13400**
Green **SG13700**
Black **SG13195**



ROUND BASE

Stainless steel base **SG13202**

- LITTER BINS -



MILTONA RECYCLED PLASTIC DOUBLE TRASH CONTAINER

- Built of heavy duty recycled plastic.
- Comes with double plastic liner bin of 50 litre each.
- Hinged heavy duty lid.
- Height x Width x Length: 90 x 46 x 82 cm.

Green	MT625665
Brown	MT625666
Black	MT625667



PATISSON TECHNOWOOD LITTER BIN - TRIPLE

- Built of heavy duty recycled Technowood.
- Comes with 3 metal trash cans of 40 litre each.
- Hinged doors for easy emptying of trash cans.
- Fixated lid to prevent from blowing open.
- Height x Width x Length: 82 x 45 x 132 cm

Brown	P78320
Green	P78321
White	P78322



PATISSON TECHNOWOOD LITTER BIN - 4-COMBO

- Built of heavy duty recycled Technowood.
- Comes with 4 metal rings to hold any 25 litre plastic bag.
- Hinged 2-sided top for easy removal of plastic bags.
- Height x Width x Length: 82 x 60 x 63 cm.

Brown	P78330
Green	P78331
White	P78332



- WATER PRO -



WATER PRO

- Double door and a built-in locking system make the cooler easily accessible.
- Features large capacity and ample cup storage, plus an onboard trash receptacle for use with large plastic trash bags.
- Front access to cooler gives you the flexibility to locate the water cooler where it's most needed.
- Weight: 87 kg.
- Height: 173 cm.
- Width: 71 cm.
- Depth: 56 cm.

WATER PRO COMPLETE

- Includes station, trash bag frame, 38 litre Hunter Green Igloo® water cooler and Igloo® cup dispenser.

Hunter Green	PA3620
Black	PA3621
Redwood	PA3622
Caramel	PA3623

WATER PRO STATION ONLY

- Includes station and trash bag frame.

Hunter Green	PA3610
Black	PA3611
Redwood	PA3612
Caramel	PA3613

WATER PRO STATION ACCESSORIES (not shown)

Igloo® Water cooler – Hunter Green	PA3657
Igloo® Cup dispenser	PA3658
Cone shaped paper cups – 5.000	PA3659
Trash recycling kit	PA3661



Trash recycling kit



Colours: Hunter Green, Black, Redwood & Caramel



WATER PRO JR.

- Post-mounted water cooler station can be conveniently located virtually anywhere on the course.
- Features locking door with front access.
- Constructed from maintenance-free 100% recycled plastic material.
- Mounting post is 15 x 15 x 183 cm recycled plastic.

Hunter Green	PA3632
Black	PA3633
Redwood	PA3634
Caramel	PA3635

- TEE TOWELS -



TRIFOLD COTTON VELOUR TEE TOWELS

- Add class to the ball washer with the trifold Pattisson tee towels.
- Made from cotton velour.
- Superior quality - can be washed and re-used.
- Available in black and green.
- Comes with an embroidered Pattisson logo.

Hunter Green, per dozen **CA15070**
 Black, per dozen **CA15071**



TRIFOLD COTTON TEE TOWELS

- Re-usable.
- With brass grommet.
- Size: 45,6 x 45,7 cm.
- Weight: 0,075 kg.
- Packed per dozen (carton = 12 dozen).

Hunter Green, per dozen **PA403**
 Black, per dozen **PA405**



TEE TOWELS

- Duo-fold.
- Size: 18 x 52 cm.
- Weight: 0,016 kg.
- Packed per 200 pieces.



ECONOMY TEE TOWELS

Lime green / white per 200 pcs **SG04969**

CHIX® DISPOSABLE TEE TOWEL

Green / white per 200 pcs **SG04965**

CHIX® WASHABLE TEE TOWELS

Green per 200 pcs **SG04970**



- RENTAL TROLLEYS -

RENTAL TROLLEYS

- Robust all steel trolley for heavy duty rental use.
- Easy to remove bag holder for rental purposes.
- Colour: Black.
- Available with 2 and 3 wheels.
- Packed: per 2 pieces.

Rental trolley, 2 wheels **LE4101010**

Rental trolley, 3 wheels **LE4101013**

Accessories

Upper Bracket **LE4101011**

Wheel **LE4101012**

Front Wheel **LE4101014**



Rental trolley, 2 wheels



Rental trolley, 3 wheels

- PLAIN FLAGS -



PATISSON HOLE FLAGS - ALL HIGH STANDARDS IN 1 PRODUCT



See page 121 for printed flags.

PATISSON FLAGS

- 400 denier white, yellow and red nylon as a standard quality for that rich look and feel.
- UV and waterproof finish for maximum colour stability and durability.
- Quadruple-edge stitching extends the life of the flag.
- Available in tube-lock version.
- Size: 36 x 50 cm.



TUBE LOCK SOLID COLOUR FLAGS (PER SET OF 9)

		400 DENIER
	SOLID WHITE	P409001
	SOLID YELLOW	P409002
	SOLID RED	P409003
	SOLID BLUE	P409004

Add an X for a single flag order

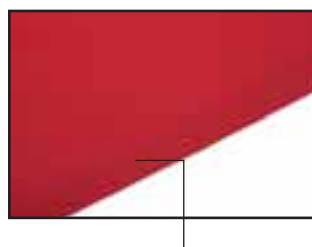

Quadruple-edge stitching extends the life of the flag.

- NUMBERED FLAGS -



PATTISSON HOLE FLAGS - ALL HIGH STANDARDS IN 1 PRODUCT

- 400 denier white, yellow and red nylon as a standard quality for that rich look and feel.
- UV and waterproof finish for maximum colour stability and durability.
- Quadruple-edge stitching extends the life of the flag.
- Available in tube-lock version.
- Size: 36 x 50 cm.

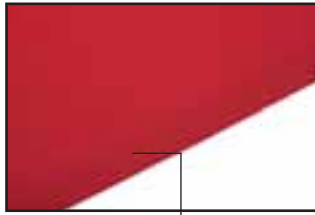

Quadruple-edge stitching extends the life of the flag.



TUBE STYLE LOCK NUMBERED FLAGS (PER SET OF 9)



RED WITH WHITE NUMBERS

1-9 **P409005**
10-18 **P409006**



WHITE WITH GREEN NUMBERS

1-9 **P409013**
10-18 **P409014**



WHITE WITH RED NUMBERS

1-9 **P409007**
10-18 **P409008**

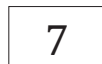

WHITE WITH BLACK NUMBERS

1-9 **P409015**
10-18 **P409016**



YELLOW WITH BLACK NUMBERS

1-9 **P409009**
10-18 **P409010**



RED WITH WHITE NUMBER SINGLE

P409019



WHITE WITH BLUE NUMBERS

1-9 **P409011**
10-18 **P409012**



WHITE WITH RED NUMBER SINGLE

P409020







- PLAIN FLAGS -



PAR AIDE FLAGS

- Improved steadfast colours, thanks to a patented DuPont® process.
- Stronger stitching, including bar-tacked corners and four rows of fly-hem stitching ensures durability in high winds.
- Also available in a 400 denier version, a heavier and more durable construction.
- Size: 36 x 50 cm.

TUBE STYLE SOLID-COLOUR FLAGS (PER SET OF 9, OR AS SINGLE)

	200 Denier	400 denier
 SOLID RED	<i>PA8102</i>	<i>PA8200</i>
 SOLID WHITE	<i>PA8112</i>	<i>PA8201</i>
 SOLID BLUE	<i>PA8122</i>	<i>PA8202</i>
 SOLID YELLOW	<i>PA8132</i>	<i>PA8203</i>
 SOLID ORANGE	<i>PA8142</i>	
 SOLID GREEN	<i>PA8162</i>	<i>PA8204</i>
 COLOUR FLAG SET (3 red, 3 white and 3 blue)	<i>PA8126</i>	<i>PA8210</i>

Add an X for a single flag order.













STANDARD GOLF FLAGS

- Material: nylon.
- Size: 36 x 50 cm.



TUBE STYLE SOLID-COLOUR FLAGS (PER SET OF 9, OR AS SINGLE)

BELOW COLOURS ONLY SOLD PER SET OF 9

 SOLID WHITE	<i>SG22200T</i>	 SOLID MAROON	<i>SG22380T</i>
 SOLID YELLOW	<i>SG22210T</i>	 SOLID BLACK	<i>SG22410T</i>
 SOLID RED	<i>SG22190T</i>	 SOLID PINK	<i>SG22420T</i>
 SOLID ORANGE	<i>SG22220T</i>	 SOLID PURPLE	<i>SG22350T</i>
 SOLID LIGHT BLUE	<i>SG22340T</i>		
 SOLID MEDIUM BLUE	<i>SG22250T</i>		
 SOLID DARK BLUE	<i>SG22260T</i>		
 SOLID GREEN	<i>SG22280T</i>		

Add an X for a single flag order.

- NUMBERED FLAGS -



PAR AIDE NUMBERED FLAGS

- Improved steadfast colours, thanks to a patented DuPont® process.
- Stronger stitching, including bar-tacked corners and four rows of fly-hem stitching ensures durability in high winds.
- Size: 36 x 50 cm.
- Per set of 9.

WHITE ON RED

Nylon	1-9	<i>PA8302</i>
Nylon	10-18	<i>PA8304</i>

RED ON WHITE

Nylon	1-9	<i>PA8312</i>
Nylon	10-18	<i>PA8314</i>

BLACK ON YELLOW

Nylon	1-9	<i>PA8332</i>
Nylon	10-18	<i>PA8334</i>

WHITE ON BLUE

Nylon	1-9	<i>PA8322</i>
Nylon	10-18	<i>PA8324</i>



STANDARD GOLF NUMBERED FLAGS

- Made of nylon.
- Size: 36 x 50 cm.
- Per set of 9.



WHITE WITH RED NUMBERS

1-9	<i>SG22111T</i>
10-18	<i>SG22110T</i>



RED WITH WHITE NUMBERS

1-9	<i>SG22101T</i>
10-18	<i>SG22100T</i>



WHITE WITH BLUE NUMBERS

1-9	<i>SG22141T</i>
10-18	<i>SG22140T</i>



YELLOW WITH BLACK NUMBERS

1-9	<i>SG22121T</i>
10-18	<i>SG22120T</i>



WHITE WITH GREEN NUMBERS

1-9	<i>SG22161T</i>
10-18	<i>SG22160T</i>



BLUE WITH WHITE NUMBERS

1-9	<i>SG22151T</i>
10-18	<i>SG22150T</i>

- CHECKERED FLAGS -

PATTISSON 400 DENIER CHECKERED FLAGS - THE KING OF FLAGS!

- 400 denier white, black, yellow and red nylon as a standard quality for that rich look and feel.
- UV and waterproof finish for maximum colour stability and durability.
- Quadruple-edge stitching extends the life of the flag.
- Available in tube-lock version.
- Size: 36 x 50 cm.



TUBE LOCK SOLID COLOUR CHECKERED FLAGS (PER SET OF 9)

 RED & WHITE *PA409021*

 BLACK & WHITE *PA409023*

 YELLOW & BLACK *PA409024*

Add an X for a single flag order



TUBE LOCK CHECKERED FLAGS (PER SET OF 9)

- Made of nylon.
- Size: 36 x 50 cm.

 RED & WHITE *PA8502*

 BLUE & WHITE *PA8512*

 BLACK & WHITE *PA8522*

 BLACK & YELLOW *PA8532*

 GREEN & WHITE *PA8562*



Finish your flags with your club logo inside the open-center design. Made to order, if you do not exactly see what you want in this catalog. No problem. Call today and ask about customizing your flag order.

TUBE LOCK SEMAPHORE FLAGS (PER SET OF 9)

- Made of nylon.
- Size: 45 x 33 cm.

Red & White *SG22300T*

Black & White *SG22400T*

Medium blue & White *SG22450T*

Green & White *SG22470T*

Black & Yellow *SG22480T*

Red & White dual numbers *SG22310T*

Pennant red & white *SG22290T*



STANDARD GOLF COMPANY



- PRINTED & EMBROIDERED FLAGS -



FULL TAILORED PRINTED FLAGS

Duchell can provide an All-inclusive for fully customised double sided printed flags:

- Available with full coverage colours and graphics.
- Possibility of different print on back side.
- 400D Nylon with reinforced corner stitching.

Double sided printed flags **DU66012**

The same print on each side

Surcharge for different print on each side **DU66015**



Different print on back side.



EMBROIDERED FLAGS

1. All-inclusive concept: price includes flag, artwork, and embroidery.

Single sided **DU66001**

Double sided **DU66002**

2. Surcharge for individual numbering on request.

Delivery time for embroidered flags 2-3 weeks.



Detailed embroidery.

- PRINTED FLAGS -



PRINTED PATTISSON 400 DENIER WHITE HOLE FLAGS - THE NEW GENERATION!

- Sublimation print allows full colour reproduction with photo quality.
- Maximum durability and stability of print due to the ink penetrating into the fibers of the flag.
- UV and waterproof finish for maximum colour stability and durability.
- Quadruple-edge stitching extends the life of the flag.
- Possibility for single sided and double sided printing.
- Size: 36 x 50 cm.



SUBLIMATION PRINT ON WHITE 400 DENIER TUBE LOCK FLAGS

Set up charge	DU61008
Full colour print per flag	DU61007
Surcharge for individual numbering	DU61009
Flag 400 D polyester white - Set	P409025
Flag 400 D polyester white - Single	P409025X
Double sided Flag 400 D polyester white - Set	P409027
Double sided Flag 400 D polyester white - Single	P409027X

Experience the fastest turnaround. Once we have final logo approval, please allow 5 working days for delivery.

See page 149 for junior printed flags.



Maximum durability and stability of print due to the ink penetrating into the fibers of the flag.

- FLAGSTICKS -



PATTISSON PRO FLAGSTICK

- Flagsticks covered with a Vinyl sleeve that is shrunk to fit the flagstick.
- Extremely durable and will not fade, chip or stain.
- UV rays or chemical will also not affect the colour of these flagsticks.
- Comes with a Pattison Pro ferrule, fits in Pattison Pro Cup.
- Size: 2,19 mtr.

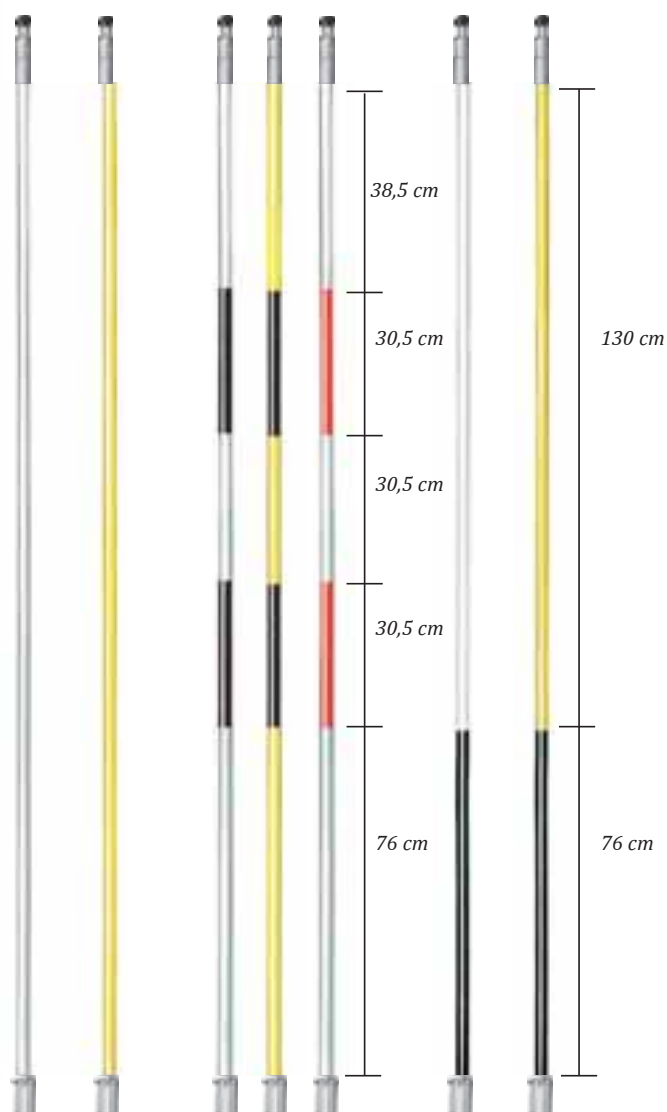

PATTISSON PRO REGULAR Ø 1,3 CM, 2,19 MTR FLAGSTICKS

Pattison Pro White	CA33001
Pattison Pro Yellow	CA33003
Pattison Pro White, 2 Black stripes	CA33002
Pattison Pro Yellow, 2 Black stripes	CA33004
Pattison Pro White, 2 Red stripes	CA33005
Pattison Pro White with Black bottom	CA33006
Pattison Pro Yellow with Black bottom	CA33007

- FLAGSTICKS -



Acorn Nut
CA33220

Extend your flagstick life easily with a replacement ferrule.

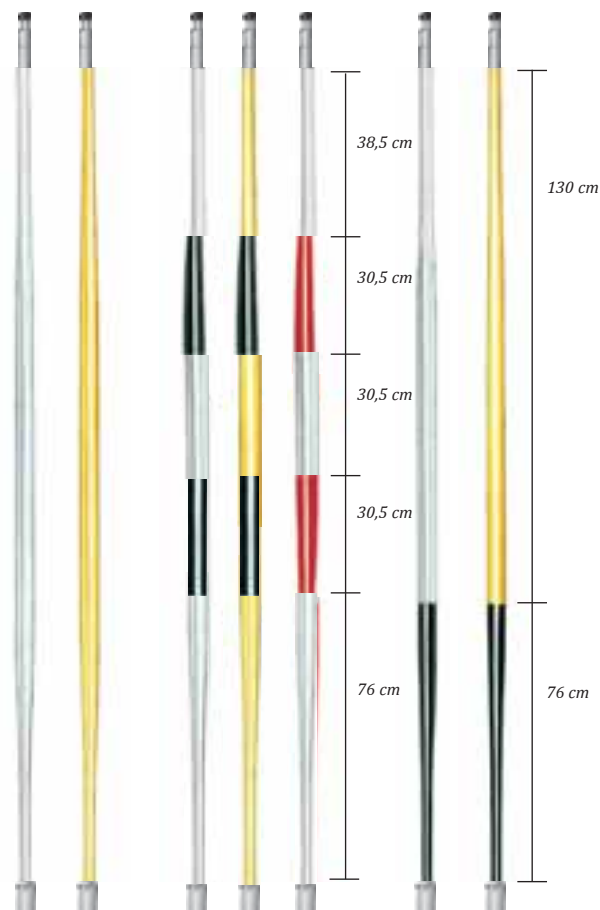

PATTISSON PRO TOURNAMENT Ø 1,9 CM, 2,19 MTR FLAGSTICKS

Pattison Pro White	CA33101
Pattison Pro Yellow	CA33103
Pattison Pro White, 2 Black stripes	CA33102
Pattison Pro Yellow, 2 Black stripes	CA33104
Pattison Pro White, 2 Red stripes	CA33105
Pattison Pro White with Black bottom	CA33106
Pattison Pro Yellow with Black bottom	CA33107

PATTISSON PRO QUICK LOCKING PIN

- Quick snap on Pattison flagsticks allows an easy exchange of tube lock flags.
- Fits Pattison flagsticks only.
- 1-piece economical construction.

CA33210



PATTISSON PRO FERRULE

- Grooves prevent the flag poles from sticking in the cup.
- Notches prevent the flag poles from turning and stops the flagsticks from twist or lean.
- Comes standard on all Pattison flag poles.
- Perfectly fits the Pattison plastic & aluminium Pro cups.

CA33200



- FLAGSTICKS -

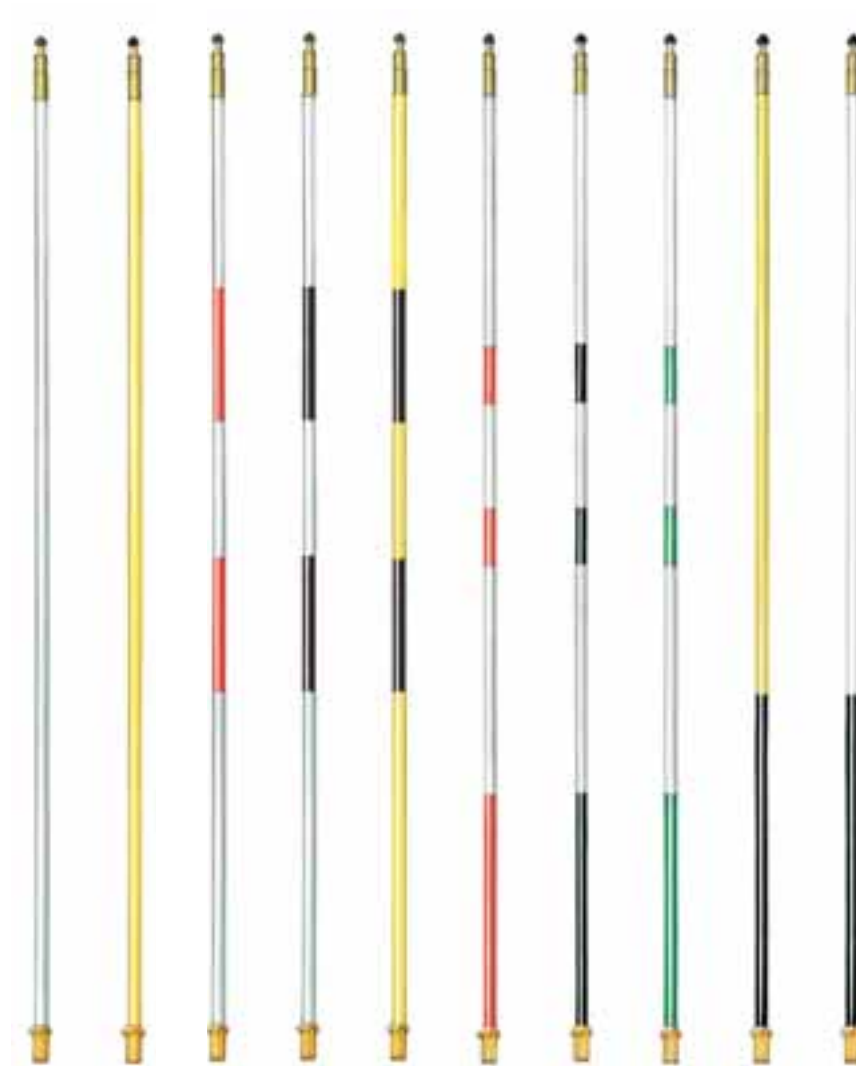

STRIPED REGULATION FIBERGLASS Ø 1,3 CM FLAGSTICKS

	1,50 MTR.	2,29 MTR.	3,05 MTR.
Bright White	PA730-05	PA730-075	PA730-10
Bright Yellow		PA740-075	PA740-10
Red & White, 2 stripe		PA725-075	
Black & White, 2 stripe		PA752-075	
Black & Yellow, 2 stripe		PA747-075	
Red & White, 3 stripe	PA720-05	PA720-075	PA720-10
Black & White, 3 stripe		PA750-075	PA750-10
Green & White, 3 stripe		PA755-075	PA755-10
Bright Yellow with Black bottom		PA745-075	PA745-10
Bright White with Black bottom		PA754-075	

FLAGSTICKS



TAPERED TOURNAMENT FIBERGLASS FLAGSTICKS

More visible and offers a solid and sturdy look and feel. They measure 2,29 mtr and taper from 1,9 cm diameter in the middle.

Extend your flagstick life easily with a replacement ferrule.

TAPERED TOURNAMENT Ø 1,9 CM FIBERGLASS FLAGSTICKS, 2,29 MTR

Bright White	PA706-07
Bright Yellow	PA707-07
British Stripe Black & White	PA708-07
British stripe Red & White	PA712-07
British stripe Green & White	PA713-07
British stripe Black & Yellow	PA714-07
Bright Yellow with 76 cm Black bottom	PA709-07
Bright White with 76 cm Black bottom	PA711-07



Acorn Nut **PA1733-6**
Package of 6

Top Stud **PA1732-6**
Package of 6



Patented Ferrule **PA1729**



QUICK LOCKING PIN

- Quick snap on system allows an easy exchange of tube lock flags.
- Fits any standard flag pole with US thread.
- Consists of brass base and plastic top (order separately).

Quick locking pin, Plastic top **P409225**
Quick locking pin, Brass base **P409226**



- VINYL COVERED FLAGSTICKS -



NEW: pink flagsticks for your ladies or girls tournament or your Pink Ribbon event. Also pink cups and flags available.

PAR AIDE VINYL COVERED

A full line of vinyl-covered flagsticks - your most durable flagstick option. These flagsticks are available in popular colour and striping patterns in both 1,3 cm and 1,9 cm models. All flagsticks come pre-applied with vinyl shrink-wrap coverings to save you time and money when considering a vinyl-covered flagstick option.

Some of the key features:

- Vinyl covered flagsticks last longer and perform better.
- Will not fade, splinter, crack, nick, scratch or stain.
- Protection against damage from abrasion, UV rays, chemicals and the elements.
- Pre-assembled for convenience, no heat gun use required.

STANDARD Ø 1,3 CM VINYL COVERED FLAGSTICKS

2,29 MTR

Bright White	<i>PA730-075-2</i>
Bright Yellow	<i>PA740-075-2</i>
2 Stripe Black & White	<i>PA752-075-2</i>
Bright Yellow with 76,2 cm Black Bottom	<i>PA745-075-2</i>
Pink	<i>PA710-099-2</i>

TAPERED Ø 1,9 CM VINYL COVERED FLAGSTICKS

2,29 MTR

Bright White	<i>PA706-07-2</i>
Bright Yellow	<i>PA707-07-2</i>
British Stripe Black & White	<i>PA708-07-2</i>



- PRISM FLAGSTICKS -

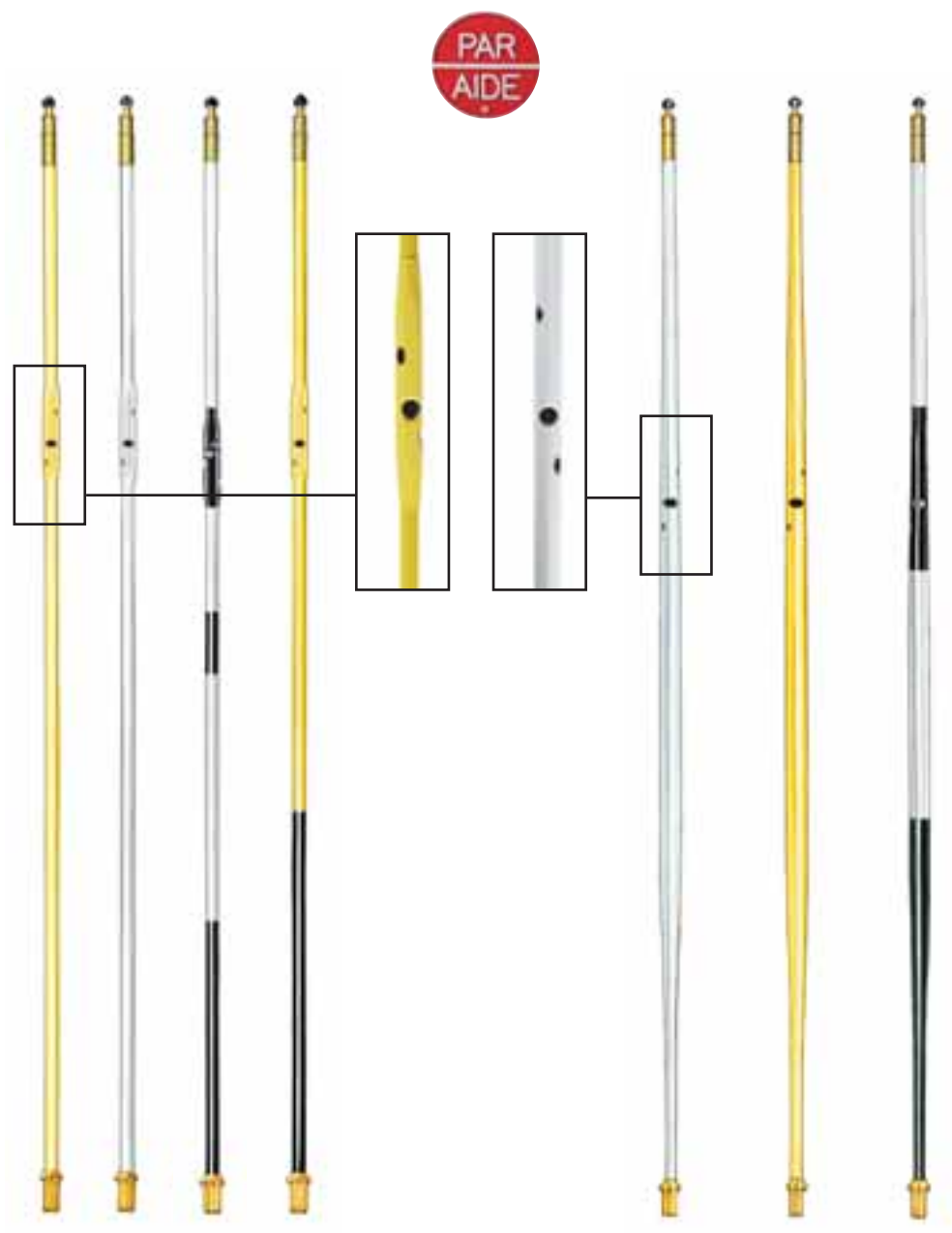

PRISM FLAGSTICKS

The Prism flagstick is here to make laser distance measuring devices easier to use and more accurate on your golf course. The Prism flagsticks integrate the reflecting prisms into the body of the flagstick.

- For use with all laser golf distance measuring devices.
- Premium glass prisms for maximum accuracy.
- Prism flagstick (available in \varnothing 1,3 cm and \varnothing 1,9 cm tapered) are machine drilled, allowing precise insertion of prisms.
- All flagsticks are 2,29 mtr tall.

	STANDARD \varnothing 1,3 CM PRISM FLAGSTICKS	TAPERED \varnothing 1,9 CM PRISM FLAGSTICKS
Bright Yellow	PA740-075-1	PA707-07-1
Bright White	PA730-075-1	PA706-07-1
British Stripe Black & White		PA708-07-1
Black & White, 3 stripe	PA750-075-1	
Bright Yellow with Black bottom	PA745-075-1	

- FLAGSTICKS -



ROYALINE Ø 1,3 CM FLAGSTICKS

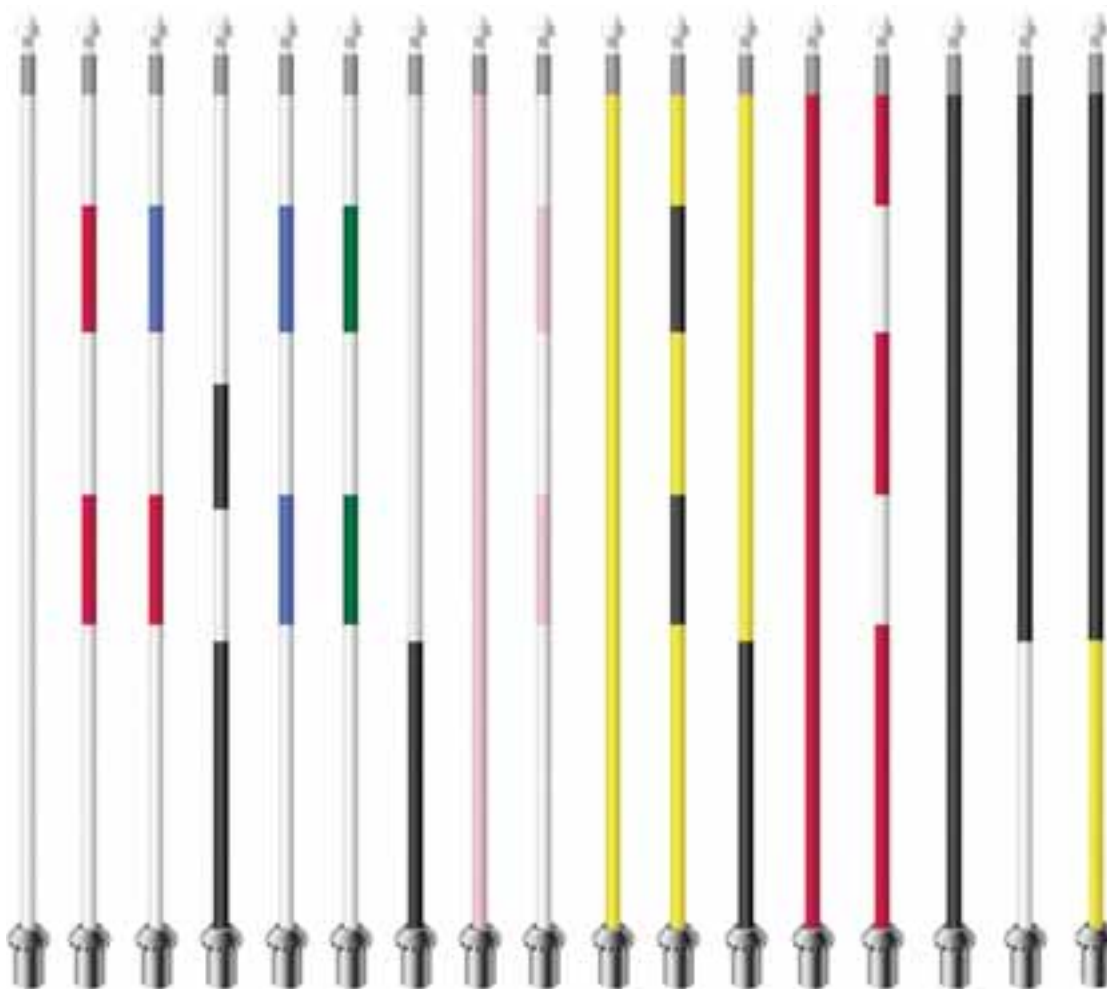

2,29 MTR. TALL

- White **SG26100**
- White / Red Stripe **SG26101**
- White / Blue & Red Stripe **SG26102**
- White / Black British Stripe **SG26103**
- White / Blue Stripe **SG26104**
- White / Green Stripe **SG26105**
- White / Black Bottom **SG26106**
- Pink **SG26107**
- White / Pink Stripe **SG26108**
- Yellow **SG26110**
- Yellow / Black Stripe **SG26111**
- Yellow / Black Bottom **SG26112**
- Red **SG26120**
- Red / White Stripe **SG26121**
- Black **SG26130**
- Black / White Bottom **SG26131**
- Black / Yellow Bottom **SG26132**

1,52 MTR. TALL

- White / Red Stripe **SG26915**
- White **SG26995**

3,05 MTR. TALL

- White / Red Stripe **SG26910**
- Yellow / Black Stripe **SG26911**
- Yellow **SG26980**
- White **SG26990**

ACORN NUT

- Acorn Nut **SG26412**

REPLACEMENT FERRULE

- For all Standard Golf Flagsticks
- SmartFit **SG26512**

- FLAGSTICKS -



TOURNAMENT FLAGSTICKS

Tournament flagsticks feature extra heft in the centre for remarkable strength, visibility and wind resistance. Order with British stripe for added visibility.

- Size: 1,3 cm diameter at the tip and ferrule, 1,9 cm diameter at the middle.

2,29 MTR. TALL

White	SG26300
White / Black British Stripe	SG26301
White / Red British Stripe	SG26302
White / Green British Stripe	SG26303
White / Black bottom	SG26304
Yellow	SG26310
Yellow / Black British Stripe	SG26311
Yellow / Black bottom	SG26314



PUTT-SAVER TOURNAMENT FLAGSTICK

- Smaller diameter at the bottom of the cup than our regular tournament flagstick thus allowing more room for the ball to fall into the cup.
- In addition to the Putt-Saver Technology, this new flagstick will also come in two pieces – saving costs when shipping.
- With a reinforced steel rod and colour fully-absorbed throughout the flagstick, this is the new leader in the clubhouse.

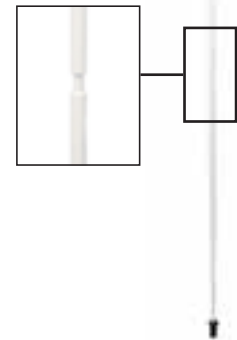

2,29 MTR. TALL

White	SG26350
Yellow	SG26360
White / Black	SG26370
White / Red	SG26380
Yellow / Black	SG26390



QUICK LOCKING PIN

- Quick snap on system allows an easy exchange of tube lock flags.
- Fits any standard flag pole with US thread.
- Consists of brass base and plastic top (order separately).

Quick locking pin, Plastic top	P409225
Quick locking pin, Brass base	P409226



SMART-FIT PRO FERRULE

- Patented solution for pre-mature wear.
- Notched-ferrule flagsticks fall right into place every time.
- Sturdy, gusset-reinforced ribs allow dirt and sand to freely sift through the cup to eliminate sticking.
- 16 tapered flanges seat the ferrule and flagstick perfectly with the Smart-Fit Cup.
- Comes standard on all Standard Golf flagstick orders.
- To help prevent chipping cups or dulling the Smart-Fit finish, the new Smart-Fit ferrules have a polymer base. This base will help increase the life of your cups!

Smart-Fit Pro Ferrule	SG26512
-----------------------	----------------

- WOODEN FLAGSTICK -



ELEGANT ACCESSORIES FOR YOUR GREENS

If you are searching for the most exclusive flagstick available, you have just found the right source.

Perennial flagsticks are an elegant combination of hardwood and brass.

- They are hand crafted, and give years of service with proper care.
- Hardwood sticks, specially cured and finished to withstand any golf environment.
- Shown is a flagstick with a golden brown stain, protected with a clear acrylic topcoat.
- We can apply a no gloss penetrating sealer if you want a "Links" presentation.
- Fiberglass rods are available in black or white, and the stock ferrule is grooved aluminum. On request we can change the ferrule to any Pattisson, Par Aide or Standard Golf ferrule.
- Wood section is 3 cm in the middle and tapers to both brass connectors.
- Various models and color combinations available.

Perennial Tournament flagstick 2,13 mtr wood **DU37060**

Perennial Practice Green Marker wood **DU37062**



- MEASURING SYSTEMS -

RANGE PAL REFLECTORS

The Range Pal Reflector is the perfect, inexpensive and simple solution for accurate distance measurements!

This nifty little cylinder just slides over the flagpole and provides a reliable target, it has a large circular and highly reflective surface which reflects back to the laser rangefinder giving the correct distance to the hole.

No more problems with other background objects confusing the rangefinder and for a reasonable price you can provide members and guests with a handy tool on the golf course.

- Reflector 1,3 cm, set of 9
- Reflector 1,3 cm, piece
- Reflector 1,91 cm, set of 9
- Reflector 1,91 cm, piece

- RP2847**
- RP2848**
- RP2849**
- RP2850**

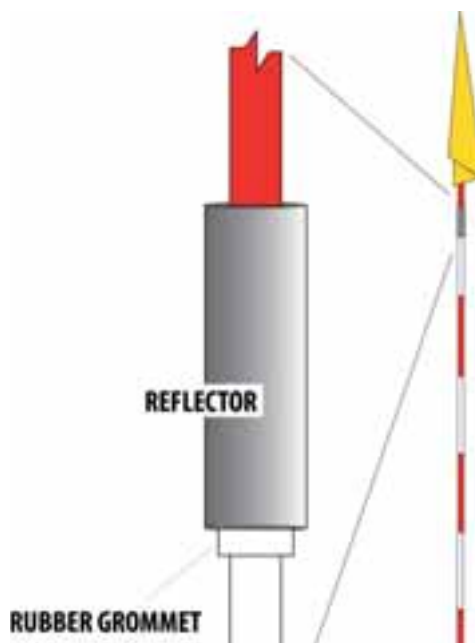

PINSITE REFLECTOR

- Convert any existing flagstick to give precise readings to laser distance measuring devices.
- Screws in place of acorn nut.
- Nylon thread prevents seizing to the top of the flagstick.



Pinsite reflector

PA1736



- PLACEMENT MARKERS -



PLACEMENT FLAGS AND MARKERS

Our placement flags and placement markers make it easy to identify cup positions on the greens. Using a rubber grommet, the tubular flags or markers can be moved up or down to signify that the hole is at the front, centre or back of the green. The flags remind players to "Please Repair Ball Marks".

- Placement flags fit flagsticks up to 1,9 cm diameter.
- Placement markers fit flagsticks up to 1,3 cm diameter. (not available for FatSticks)



PLACEMENT FLAGS (SET OF 9 INCL. GROMMETS)

- Made of nylon.
- Weight: 0,23 kg.
- Size: 12 x 19 cm.

Red for 1,3 cm flagstick **SG05335**
 Yellow for 1,3 cm flagstick **SG05355**

Red for 1,9 cm flagstick **SG05337**
 Yellow for 1,9 cm flagstick **SG05357**

Rubber Grommet for 1,3 cm flagstick **SG05354**
 Rubber Grommet for 1,9 cm flagstick **SG05360**



PLACEMENT MARKERS

- Sold individually with grommet.
- Fits 1,3 cm diameter flagsticks only.
- Weight: 0,04 kg.



Red
SG05350

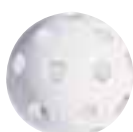

White
SG05351



Blue
SG05352



Yellow
SG05353

- PLACEMENT FLAGS -



Front, middle or back, golfers will know the pin position with the help of these indicators.

- Tube-Style flags - 15,2 x 17,8 cm - held in place by rubber grommets.
- Available for every size of flagstick: 1,3 cm, 1,9 cm and 2,5 cm.
- Solid-colour flags with print "Please Repair Ball Marks" or plain or a custom message.

PLACEMENT FLAGS

FOR Ø 1,3 CM FIBERGLASS FLAGSTICKS (SET OF 9)

Plain Red	<i>PA770-01</i>
Plain White	<i>PA770-02</i>
Plain Yellow	<i>PA770-03</i>
Plain Blue	<i>PA770-04</i>
Red with White printing	<i>PA775-01</i>
White with Red printing	<i>PA775-02</i>
Yellow with Black printing	<i>PA775-03</i>
Blue with White printing	<i>PA775-04</i>



FOR Ø 1,9 CM TAPERED TOURNAMENT FLAGSTICKS (SET OF 9)

Plain Red	<i>PA790-01</i>
Plain White	<i>PA790-02</i>
Plain Yellow	<i>PA790-03</i>
Plain Blue	<i>PA790-04</i>
Red with White printing	<i>PA795-01</i>
White with Red printing	<i>PA795-02</i>
Yellow with Black printing	<i>PA795-03</i>
Blue with White printing	<i>PA795-04</i>

REPLACEMENT GROMMETS (SET OF 9)

For Ø 1,3 cm Flagsticks	<i>PA780-9</i>
For Ø 1,9 cm Flagsticks	<i>PA796-9</i>



- PUTTING CUPS -



Nothing looks worse than a flagstick leaning to one side. This happens when the cup and ferrule get worn out due to windy conditions together with dirt, sand and grit that get in between the ferrule and cup. Often the flagstick gets stuck when golfers try to remove the flagstick from the hole.

WE HAVE THE SOLUTION!

With the Pattisson Pro Cup and the Pattisson ferrule the flagstick will always click into place, meaning that the flagstick cannot turn around in the cup. Also the grooved ferrule makes sure that the dirt and sand pass through the cup leaving the cup and ferrule clean.

No more sticking and flagsticks standing perfectly straight, as they should!

The bright white sleeve can be placed inside the aluminium cup to create a white hole cup, that has the traditional sound of an aluminium cup but without chipped paint. When the white sleeve gets dirty, just replace them.

Or why not personalise the cup with your logo? The ferrule also has the same effect in combination with the Pattisson plastic cup.



-PUTTING CUPS-



PATTISSON ALUMINIUM PRO HOLE CUP

- Aluminium.
- Easy to set and fit.
- Pattison pro flagsticks fits perfectly.
- Flagsticks do not lean or turn in cup.
- No chipped paint.
- Size: 15 x 10,8 cm.
- Packed: 9 per carton.

CA29420



SLEEVE PATTISSON PRO CUP

- Easy to set and fit.
- Gives the cup a clean white look.
- Can be printed with logo (not a sticker that gets dirty).
- Set of 18.

CA29424 (Set of 18)

LOGO SLEEVE PATTISSON PRO CUP

CA29425 (PCS)

CA29426 Set up charge

Minimum quantity logo sleeves: 9 pcs.



PATTISSON PLASTIC HOLE CUP

- Brilliant white.
- Made of rugged engineered grade polymers for resistance to chemicals.
- Tapered sides allow easy removal from the hole.
- Size: 15 x 10,8 cm.
- Packed: 9 per carton.

CA29311



PATTISSON ALUMINIUM HOLE CUP

- Easy to set and fit.
- Constructed of high grade aluminium.
- Stark white powder coated finish for better visibility.
- Corrosion resistant.
- Virtually unbreakable.
- Size: 15 x 10,8 cm.
- Packed: 9 per carton.

CA29414



- PUTTING CUPS -



Four distinctive styles, each with the hallmark of Par Aide products: durability, great appearance and impeccable quality. Your choices include the brightest white plastic cup in the industry, our traditional machined aluminium cup, and our patented Ever-White Cup, the one you've heard about with replaceable sleeves.

EVER-WHITE CUP

The patented Ever-White™ Cup has revolutionised the category by teaming an aluminium outside with a bright white plastic sleeve.

- No paint to chip, eliminating the need for stripping, sanding and painting.
- Easily replaceable sleeve stays tight in the cup during play.
- Resonates with the classic aluminium sound when the ball drops in.



PATENTED ALUMINIUM CUP COMPLETE WITH PLASTIC SLEEVE

- Meets all USGA regulations.
- Size: 15 x 10,8 cm.
- Weight: 0,9 kg.
- Packed: 9 per carton.

PA935



EVER-WHITE CUP REPLACEMENT SLEEVES

- Case of 18

PA935-1



CUSTOM DECAL FOR EVER-WHITE SLEEVE

Customize your hole cup.

We offer you the option of personalizing your hole cup. Because it is the sleeve that is personalized, it can be easily replaced, for example for a sponsored tournament.

PA520-1

- PUTTING CUPS -



PLASTIC CUPS

- Durable bright white Cicolac® plastic cups featuring minimum taper for a snug fit, both on the course and on the practice green.
- Size: 15 x 10,8 cm.
- Weight: 0,23 kg.
- Packed: 9 per carton.

PA920



PRACTICE GREEN PLASTIC CUPS

- Durable bright Cicolac® plastic cups featuring minimum taper for a snug fit.
- Size: 10 x 10,8 cm.
- Weight: 0,23 kg.
- Packed: 9 per carton.

PA940



ALUMINIUM CUPS

- Our classic model, it's die cast oversize, then machined down to precision dimensions to minimise "wobble" in the hole.
- Surfaces anodised and dichromated for ultimate corrosion protection.
- The cup's vertical surfaces are powder-coated bright white. The bottom of the cup is not powder-coated, so there's no paint to chip.
- Size: 15 x 10,8 cm.
- Weight: 0,9 kg.
- Packed: 9 per carton.

PA930



- PUTTING CUPS -

**STANDARD
GOLF COMPANY**



ST2000™ NON-STICK CUP

The innovative ST2000™ design allows soil to pass down the sides and through the cup. This keeps the cup's socket dirt free and eliminates the ferrule from sticking. Contact points hold the flagstick firmly in place. A dirty ferrule just can not stick in the ST2000™.



PLASTIC ST2000™

- Brilliant white.
- High strength plastic cups.
- Molded with polymers that resist chemicals provide a brilliant, lasting finish.
- Meets all USGA regulations.
- Size: 15 x 10,8 cm.
- Packed 9 per carton.

SG18222



ALUMINIUM ST2000™

- Brilliant white finish.
- Creates a distinctive sound when ball drops.
- Bonderite coated aluminium cups.
- The most chip-resistant coating around.
- Meets all USGA regulations.
- Size: 15 x 10,8 cm.
- Packed 9 per carton.

SG18333



HYBRID ST2000™

- The popular ST2000 Smart-Fit Cup has a third configuration.
- A "hybrid", with an aluminium base and plastic molded walls, combines the best of our aluminium and plastic ST2000 models.
- The aluminium base gives maximum strength as the notched ferrule fits perfectly into place, eliminating twisting, sticking and sinking.
- Plastic molded cup walls prevent chipping and provide a long-lasting finish.
- An aluminium bottom allows for the "traditional sound" of a golf ball hitting the bottom of the cup.
- Meets all USGA regulations.
- Size: 15 x 10,8 cm.
- Packed 9 per carton.

SG18444

- PUTTING CUPS -

**STANDARD
GOLF COMPANY**

RIJI CUP

- Brilliant white.
- Made of rugged engineered grade polymers for resistance to chemicals.
- Tapered sides allow easy removal from the hole.
- Meets all USGA regulations.
- Size: 15 x 10,8 cm.
- Packed 9 per carton.

SG18200



ALUMINIUM CUP

- Easy to set and fit.
- Constructed of high grade aluminium.
- Stark white powder coated finish for better visibility.
- Corrosion resistant.
- Virtually unbreakable.
- Size: 15 x 10,8 cm.
- Packed 9 per carton.

SG18303



PRACTICE GREEN CUP

- Constructed of molded plastic.
- Stronger webs for eliminating warping and assuring a consistently round, easy setting cup.
- Precise inside tolerance holds the practice green marker securely in place.
- Size: 10 x 10,8 cm.
- Packed 9 per carton.

SG18100



ALUMINIUM PRACTICE GREEN CUP

- Bonderie aluminium with the most chip resistance coating around.
- Beveled bottom edge design makes them much easier to insert and remove.
- Size: 10 x 10,8 cm.
- Packed 9 per carton

SG18150



- EVENT CUPS & SURE PUTT -

Please see page 202 for matching hole cutters.



38,1 CM EVENT CUP

Made of durable white plastic to stand up to the elements, it provides an incredibly inviting target for youth and beginning golfers.

Plastic cup Ø 38,1 cm and 7,62 cm high **PA927**



20,2 CM EVENT CUP

Made of durable white plastic to stand up to the elements, it is a great way to grow the game by giving beginners and easier target. Its durability makes it the cup to choose for "Big cup" and junior events.

Plastic cup Ø 20,2 cm and 7,62 cm high **PA925**

**STANDARD
GOLF** COMPANY



SPECIAL EVENT & WINTER CUP

- Powder-coated steel cup in 15,2 cm and 20,2 cm sizes.
- Plastic winter cup available in 20,2 cm.
- Fits standard-sized flagsticks.
- Great addition for "big hole" events.
- Height in 2 sizes: 15 cm and 8 cm.

Steel cup Ø 15,2 cm and 15 cm high **SG18600**

Steel cup Ø 20,2 cm and 8 cm high **SG18700**

Steel cup Ø 20,2 cm and 15 cm high **SG18710**

Plastic cup Ø 20,2 cm and 8 cm high **SG18775**



SURE PUTT PRACTICE GREEN SYSTEM

Putting to the smaller cup, 8 cm diameter compared to a regulation cup (10,8 cm), dramatically helps focus the golfer's aim and trains them to make a more accurate putting stroke.

The Sure Putt Practice Green System is a complete system that is widely regarded as the finest putting aid for any level of golfer.

Offered at a tremendous value, it includes:

- Hole cutter.
- 3 Metal Putting cups 8 x 9 cm.
- Cup puller.
- A sign to explain how the system works.

Complete Sure Putt Practice Green System **PA10710**

Replacement putting cup only **PA10702**

- PUTTING CUPS ACCESSORIES -

CUP COVER

- Rotate cup covers instead of cups during low play seasons.
- Keeps hole free of top dressing material and debris.
- Fits any regulation cup size.
- Fits flush with top of green.
- Available in 3 sizes.
- 10,8 cm cover is power coated steel.
- 15,2 cm and 20,3 cm covers are power coated aluminum.
- Depth: 2,5 cm.

10,8 cm Cup Cover **SG18500**

15,2 cm Cup Cover **SG18650**

20,3 cm Cup Cover **SG18750**

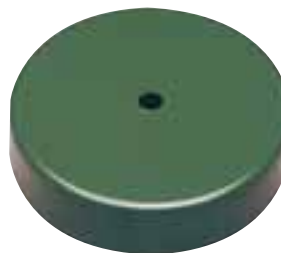

RECYCLED RUBBER CUP COVER

Use these economical, environmentally friendly cup covers instead of rotating cups during low playing seasons or when top dressing.

- Made from recycled tires.
- Fits any regulation size cup.
- Durable, yet won't damage mower wheels if nicked.
- Available in 3 sizes.
- Depth: 2,5 cm.

10,8 cm Cup Cover **CA29455**

15,2 cm Cup Cover **CA29456**

20,3 cm Cup Cover **CA29457**



RESIN CUP COVER

Resin hole cup cover with synthetic grass.

Resin cup cover **PCA559**



CUP PLUGS

- Made from durable, lightweight, weather-resistant foam material.
- Used when aerating greens to protect the integrity of the hole.
- Used when topdressing greens to keep sand from filling up cup hole.
- Can be left in holes during winter months.
- Aeration tines able to penetrate plug without pulling it out of the hole.
- Can be used 2 - 3 times.
- Sold per 9 pieces.

Regulation cup size, pack of 9 pcs **PA1070**

Practice cup size, pack of 9 pcs **PA1071**



COMPLETE PRODUCT RANGE OF THE LATEST RAGE

FootGolf is growing rapidly worldwide and now Duchell offers a complete product line for this sport. Products include the official size FootGolf cup, logo flag, FootGolf tee markers and information signs.

The FootGolf cup is an extremely sturdy cup with an artificial grass top to discretely cover the cup.

In combination with the logo flags, information signs and the eye-catching tee markers, a golf course can create the perfect platform for a wider range of customers.



FOOTGOLF CUP WITH COVER

- Extremely sturdy.
- Lid with artificial grass to cover cup when not in use.
- Official FootGolf size: Ø 52 cm.
- Depth: 35 cm.

CA29600



- FOOTGOLF -

FOOTGOLF TEE MARKER

- Heavy & solid.
- Looks like a miniature football.
- Practically unbreakable.
- Easily stuck into the ground and removed.
- Steel spike.
- Size: Ø 15,5 cm.
- Weight: 3,65 kg.

CA29650



FOOTGOLF DIMPLE TEE MARKER

- Lightweight tee markers.
- Easily stuck into the ground and removed.
- Black golf ball with football image.
- Steel spike.
- Size: Ø 13 cm.
- Weight: 0,29 kg.

CA29685



DIRECTION SIGN INCLUDING ARROW

- Including arrow.
- Clear signage to show players the route.
- Easily stuck into the ground and removed.
- Numbers to be ordered separately.
- Size: 30 x 20 cm.

CA29660

DECALS

Decal numbering 1-9 **CA29661**

Decal numbering 10-18 **CA29662**



FOOTGOLF FLAGS

- High quality polyester flags.
- Sublimation printed FootGolf flags.
- Maximum durability and stability of print.
- UV and waterproof finish.
- Quadruple-edge stitching extends the life of the flag.
- Size 36 x 50 cm.

Set of flags 1-9 **CA29670**

Set of flags 10-18 **CA29671**



- PRACTICE GREEN MARKERS -



Choose your own colour combination.
Order: head, rod en base separately.

Our line of practice green markers allow you to built your own marker to your own liking. Order base, different coloured rods, heads or flags to match your requirements.

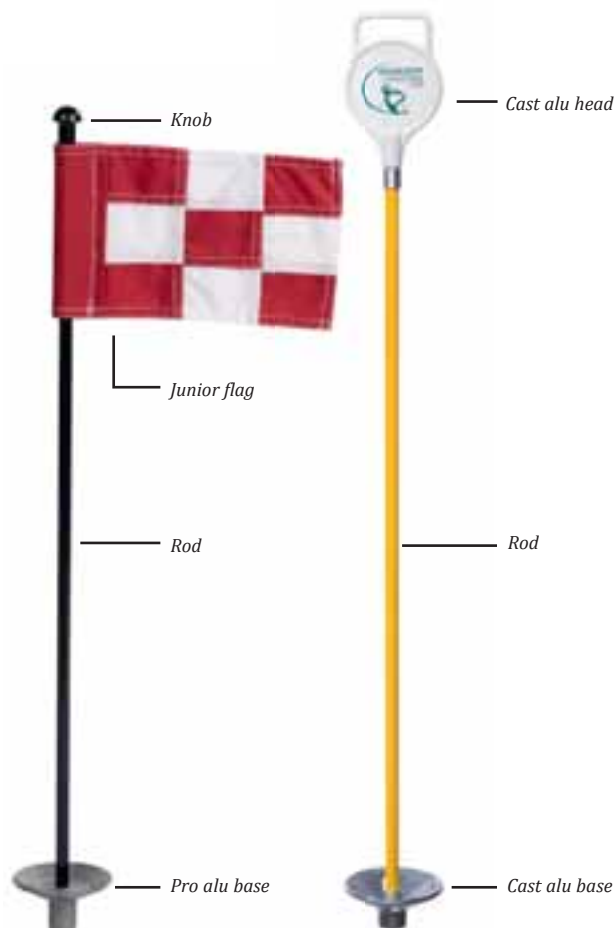

CAST ALUMINIUM PRACTICE GREEN MARKERS

- Available in several attractive powder coated colours.
- Handy built-in grip.
- Full 1,3 cm diameter stick.
- Size: 75 cm.
- Can be personalised with decals featuring logo.
- Order stickers with numbers, in sets only.

FIBREGLASS ROD Ø 1,3 CM

Red	CA31293
Black	CA31393
White	CA31493
Yellow	CA31593
Blue	CA31693
Green	CA31793

METAL BASES

Cast alu base	CA31433
Pattison Pro alu base	CA32100

KNOP FOR PRACTICE GREEN FLAGS

Knob for practice green flag	CA31933
------------------------------	----------------



Recognize this?



Solution: Pattison Pro alu base



PATTISSON PRO ALU BASE

- New design aluminium extended base prevents junior flags to 'lean'.
- Bottom ridges for extra stability.

Pattison Pro alu base	CA32100
-----------------------	----------------

- PRACTICE GREEN MARKERS -



CAST ALUMINIUM HEAD

White	CA31643
Yellow	CA31644
Red	CA31645
Green	CA31646
Blue	CA31647
Black	CA31648



STICKER SETS OF NUMBERS FOR CAST ALUMINIUM MARKERS

- Set of 9 includes two of each number.

Set 1-9, *Please state colour* **CA31652**

Set 10-18, *Please state colour* **CA31651**

Sticker for cast aluminium head

- Diameter stickers 70 mm.

<18 pcs **STICKER DP1**

19-36 pcs **STICKER DP2**

>37 pcs **STICKER DP3**



Cast alu head with personalised sticker or with numbers.

JUNIOR FLAGS

- Size: 20 x 12 cm.

PLAIN JR. FLAGS (Set of 9)

	Red	PA9200
	White	PA9202
	Blue	PA9204
	Yellow	PA9206



Plain flags

CHECKERED JR. FLAGS (Set of 9)

	Red & White	PA9300
	Black & White	PA9320
	Black & Yellow	PA9330
	Green & White	PA9360



Checkered flags

NUMBERED JR. FLAGS (Set of 9)

	White on Red 1-9	PA9251
	White on Red 10-18	PA9252
	Red on White 1-9	PA9261
	Red on White 10-18	PA9262
	Black on Yellow 1-9	PA9281
	Black on Yellow 10-18	PA9282



Numbered flags

PERSONALIZED FLAGS

Personalized (sublimation print or embroidered) versions.
See page 148 and 149.



Personalized flags

KNOP FOR PRACTICE GREEN FLAGS

Knob for practice green flag **CA31933**

- PRACTICE GREEN MARKERS -



JR. FLAGSTICKS

- Made from 1,3 cm fibreglass.
- Non-tip, moulded plastic base for convenient ball extraction.
- Including accorn nut.
- Weight: 0,31 kg.
- Size: 78,7 cm.

Bright White	PA9190
Bright Yellow	PA9191
Red & White	PA9192
Black & White	PA9193
Green & White	PA9194
Black & Yellow	PA9195

Order flags separately.



WOODEN PRACTICE GREEN MARKER

Attract more golfers to the practice green with the handsome Natural Wood Practice Green Markers. Not only do they improve the look of the practice green, these markers complement the classic look of golf.

- Made of extremely strong Brazilian hardwood.
- Flagstick is 86 cm tall for the golfers convenience.
- Finished with natural teak oil. To restore luster, re-apply teak oil periodically.

Wooden practice green marker	PA9120
Optional wooden knob (set of 9)	PA9098-9



EXECUTIVE PUTTING GREEN MARKERS

- Available in red and hunter green, with or without numbers.
- Non-tip designed base.
- Fully assembled.
- Weight: 0,30 kg.
- Size: 83,8 cm.
- Sold in set of 9.

Red plain	PA9170-01
Red 1-9	PA9171-01
Red 10-18	PA9172-01
Hunter Green plain	PA9170-02
Hunter Green 1-9	PA9171-02
Hunter Green 10-18	PA9172-02

- PRACTICE GREEN MARKERS -

EXTRA LARGE PRACTICE GREEN MARKER

- Extra large plastic marker head for better visibility of logo or numbering.
- Available in white only.
- Fits fibre rod & cast aluminium base.
- Head size: 26 x 14 cm.

Plastic marker head only **PC20532**

Fibre rod for plastic marker head **PC20533**

Pattisson Pro alu base **CA32100**

Sticker **STICKERXL**



STANDARD
GOLF COMPANY

NUMBERED PRACTICE GREEN PENNANT SETS (SET OF 9)

- Classic, one piece plastic head and fiberglass rod combinations.
- Order them in a set of nine 1-9 or 10-18.
- Rod 1 cm diameter.
- 71 cm long.
- With rod and aluminium base.

Numbered practice green pennant flags

Set 1-9 white / red **SG20391**

Set 10-18 white / red **SG20390**

Set 1-9 white / green **SG20491**

Set 10-18, white / green **SG20490**

Set 1-9 black / yellow **SG20591**

Set 10-18 black / yellow **SG20590**

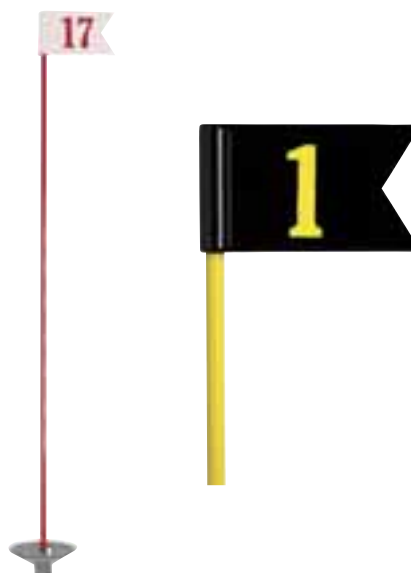

- JUNIOR FLAGS -



JUNIOR FLAGS

• Size: 20 x 12 cm.

PLAIN JR. FLAGS (Set of 9)

- Red **PA9200**
- White **PA9202**
- Blue **PA9204**
- Yellow **PA9206**



CHECKERED JR. FLAGS (Set of 9)

- Red & White **PA9300**
- Black & White **PA9320**
- Black & Yellow **PA9330**
- Green & White **PA9360**



NUMBERED JR. FLAGS (Set of 9)

- White on Red 1-9 **PA9251**
- White on Red 10-18 **PA9252**
- Red on White 1-9 **PA9261**
- Red on White 10-18 **PA9262**
- Black on Yellow 1-9 **PA9281**
- Black on Yellow 10-18 **PA9282**



EMBROIDERED JUNIOR FLAGS

All-inclusive concept: price includes flag, artwork and embroidery.

Single sided **DU66003**

Double sided **DU66004**

Surcharge for individual numbering on request.

Delivery time for embroidered flags 2-3 weeks.

- JUNIOR FLAGS -



PRINTED PATTISSON 400 DENIER WHITE HOLE FLAGS - THE NEW GENERATION!

- Sublimation print allows full colour reproduction with photo quality.
- Maximum durability and stability of print due to the ink penetrating into the fibers of the flag.
- UV and waterproof finish for maximum colour stability and durability.
- Quadruple-edge stitching extends the life of the flag.
- Possibility for single sided and double sided printing.
- Size: 25 x 15 cm.

SUBLIMATION PRINT (ON WHITE FLAGS ONLY)

Setting-up charge	<i>DU61008</i>
Full colour print on white junior flag	<i>DU61011</i>
Surcharge for individual numbering	<i>DU61009</i>
Flag 400 D polyester white - Set	<i>P409125</i>
Flag 400 D polyester white - Single	<i>P409125X</i>
Double sided Flag 400 D polyester white - Set	<i>P409127</i>
Double sided Flag 400 D polyester white - Single	<i>P409127X</i>

Experience the fastest turnaround. Once we have final logo approval, please allow 5 working days for delivery.



- BENCHES -



PATTISSON TECHNOWOOD BENCHES

The new Technowood is a product similar to wood but does not present the limitations of the wood itself; it is made out of recycled PVC & Fiberglass and finished with a surface film giving a full 10 year warranty on colour retention and an estimated life of 30 years! No maintenance required at all and endless product possibilities.

The main advantages:

- Impact and pressure resistant.
- Resistant to water, humidity, heat and frost.
- UV resistant with a full 10 year colour retention guarantee.
- Absolutely maintenance free.
- Workability and fixing such as wood.
- Estimated lifetime of 30 years.



BENCH TECHNOWOOD 155 CM COMFORT

- Size: length 155 x width 70 x height 95 cm.
- Seat height: 45,5 cm.

Brown
Green
White

P78214
P78215
P78216



BENCH TECHNOWOOD 147 CM BACKLESS

- Size: length 147 x width 50 x height 45 cm.
- Seat height: 45,5 cm.

Brown
Green
White

P78210
P78211
P78209



- BENCHES -



TEAK BENCHES

The traditional design and classical looks of our range means the products we offer are not just for “on the course” but they also look at home around the clubhouse terrace.

All benches are flat packed (for easy assembly).

- Made of top quality teak wood.
- Teak harvested along the international regulations regarding conserving the forrest by replanting trees.
- Handmade to get that original traditional look.

Walmer bench 180 x 60 cm **MX41013**



For maintenance of the wood, please see page 70.

Junior bench 100 x 45 cm **MX41010**



- ON THE TEE ACCESSORIES -



PAR AIDE COOLER PRO

- Recycled plastic housing - maintenance free.
- Chic, low profile option for keeping refreshments cold on the course.
- Comes complete with a removable Igloo cooler.
- Cooler lid attaches to Cooler Pro for convenience or can be detached to use cooler separately.

COOLER PRO

- Weight 26,8 kg
- Size 68,8 (W) x 45,7 (D) x 48,3 cm (H)
- 36 litre cooler.

Hunter Green **PA3330**

Black **PA3331**

Redwood **PA3332**

Caramel **PA3335**



COOLER PRO 100

- Weight 50,8 kg
- Size 97,8 (W) x 51,4 (D) x 67,3 cm (H)
- 94,6 litre Cooler

Hunter Green **PA3340**

Black **PA3341**

Redwood **PA3342**

Caramel **PA3343**

Colours: Hunter Green, Black, Redwood & Caramel



PAR AIDE RANGE BALL STORAGE BOX

- Sturdy storage box holds up to 5.000 golf balls.
- Powder coated metal bottom allowing golf balls to vent and dry.
- Dual top opening for easy acces.
- Recycled plastic wood-slats are rustproof and fade resistant.
- Fully lockable.
- Size: 97,8 cm (W) x 70,8 cm (D) x 67,9 cm (H).

Range ball storage box, Hunter Green **PA3350**

Range ball storage box, Black **PA3351**

Range ball storage box, Redwood **PA3352**

Range ball storage box, Caramel **PA3353**



- CLOCKS -

CLOCK KIT

- Comes complete with outdoor clock and mounting kit.
- Pre-drilled holes in mounting bracket enables clock to be mounted to any Par Aide recycled plastic unit or on any other location of your choice.
- Size: Ø 39,5 cm.

Clock kit

PA3690



WALL CLOCK

- Stylish 'Station Type' double sided wall clock.
- Diameter: 40 cm.
- Aluminium housing.
- Radio controlled - always the exact time.
- Automatic change from summer to wintertime.
- Powered by 2x AA battery (penlite) – not included.
- Not waterproof, to be mounted in covered area only.

Wall Clock

MX38115



PATISSON TECHNOWOOD CLOCK / MESSAGE KIT

The new Technowood is a product similar to wood but does not present the limitations of the wood itself; it is made out of recycled PVC & Fiberglass and finished with a surface film giving a full 10 year warranty on colour retention and an estimated life of 30 years! No maintenance required at all and endless product possibilities.

The main advantages:

- Impact and pressure resistant.
- Resistant to water, humidity, heat and frost.
- UV resistant with a full 10 year colour retention guarantee.
- Absolutely maintenance free.
- Workability and fixing such as wood.
- Estimated lifetime of 30 years.



CLOCK / MESSAGE KIT

- Multipurpose message kit .
- Foldable for easy removal.
- Excluding clock.

Brown

P78610

Green

P78611

White

P78612

- ATOMIC CLOCK -



ATOMIC CLOCK 'INKA'

- Outdoor clock with galvanised steel case in 3-layer black lacquering finish.
- Clock face available with Roman or Arabic numerals.
- Highest standard clockwork movements warrant the perfect time all the time!
- Automatic time setting by aide of a radio transponder.
- Self-adjusting; clock automatically finds the right time zone and adjusts to summer- and wintertime.
- Shown on a stainless steel mounting frame with optional sponsor sign bracket.
- Wide variety of brackets and frames available.
- Height: 260 cm, Width: 81 cm.
- Complete with Lithium battery.
- As shown the frame will hold a 60 x 25 cm sponsor sign underneath the clock.

Clock 'Inka' **MX38111**
Stainless Steel Mounting frame **MX38112**



- INFORMATION SIGNS -



TEAK SERIE SIGNS

- Made of top quality teak wood.
- Teak harvested along the international regulations regarding conserving the forrest by replanting trees.
- Handmade to get that original traditional look.
- Size: (H) 57 x (W) 35 x (D) 5 cm.
- Standard with stainless steel spike.



TEAK SERIE SIGNS

CHIPPING GREEN	DU82306
PUTTING GREEN	DU82307
TEE 10 →	DU82308
← TEE 10	DU82309
← CARTS	DU82339
CARTS →	DU82391
G.U.R.	DU82315
NEXT TEE*	DU82337LR

*with → double sided, can be used both ways.

Customised **DU82334**
 Allow long lead time for customized teak signs.

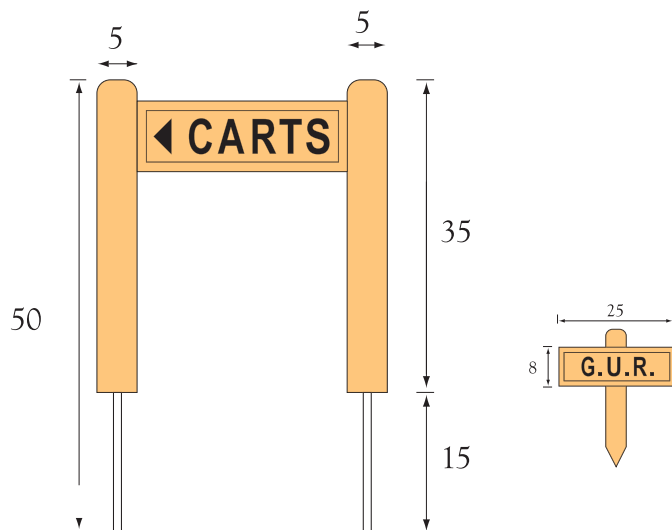

- INFORMATION SIGNS -



DURA-FLEX™ SIGNS

- 3-D molded-in letters means printing will not scratch off.
- U-shaped stainless steel spike, molded into the resin.
- Flexible and impervious to damage from balls and trolleys.
- Available in White, Green and Yellow.
- Size: 27 x 14 cm.

SIGNS:

- | | |
|---------------------------|---------------|
| White with Green letters | PA5610 |
| Green with White letters | PA5620 |
| Yellow with Black letters | PA5630 |



Unique U-shaped Spike(s)



CAPITONS AVAILABLE FOR DURA-FLEX SIGNS:

- | | | |
|------------------------------|---------------------------|-----------------|
| -01 Ground Under Repair | -09 Please Replace Divots | -18 Carts → |
| -02 Tee Area Closed | -10 Please Keep Off | -19 ← Next Tee |
| -03 No Carts Past Here | -11 Carts Scatter | -20 Next Tee → |
| -04 Keep Carts On Path | -12 Putting Green Closed | -22 Trolleys → |
| -05 Please Rake Bunkers | -13 No Chipping | -23 ← Trolleys |
| -06 Please Repair Ball Marks | -14 Next Tee ↑ | -24 No Trolleys |
| -07 Drop Area | -16 No Carts | -25 Drop Zone |
| -08 Wet Area Carts Keep Off | -17 ← Carts | |



WOOD DIRECTIONAL SIGNS

- Give your golf course a timeless, traditional look with our new hardwood sign.
- Letters are routed and painted.
- Each sign is individually hand oiled to maintain a rich, hard wood colour.
- Stainless steel spikes.
- Size: 27 x 14 x 2 cm.

Wood directional sign

PA5660



CAPITONS AVAILABLE FOR WOOD DIRECTIONAL SIGNS:

- | | | |
|------------------------------|--------------------------|-----------------|
| -01 Ground Under Repair | -07 Putting Green Closed | -14 No Chipping |
| -02 Tee Area Closed | -08 Please Keep Off | -15 Drop Zone |
| -03 Keep Carts On Path | -09 Carts → | -16 ← Carts |
| -04 No Carts Past Here | -10 Next Tee → | -17 ← Next Tee |
| -05 Please Repair Ball Marks | -12 No Carts | |
| -06 Drop Area | -13 Native Area No Carts | |

- INFORMATION SIGNS -



SIGN PATTISSON

- Staked sign.
- Colour: white.
- Please indicate required text for custom sign.

SIGN PATTISSON 30 X 20 CM

Pattison spiked sign 30 x 20 cm white **PCA707**
Please order sticker separatly.



STICKERS SIZE 30 X 20 CM, GREEN ON WHITE

Sticker Next Tee	PCA707/NT
Sticker Out of Bounds	PCA707/OB
Sticker Ground under repair	PCA707/GUR
Sticker Trolleys this way	PCA707/TTW
Sticker Please repair divots	PCA707/PRD
Sticker Please repair pitch marks	PCA707/PRP
Sticker Custom text	PCA707/C



GREEN LINE FAIRWAY SIGNS

- Single or double sided signage with 13 cm galvanized screw-in stakes.
- Choice of 2 sizes: 23 cm x 38 cm or 15 cm x 30 cm.
- Tough, long-lasting laminated material.
- Outstanding fade-resistance.



GREEN LINE FAIRWAY SIGNS SINGLE SIDED

	15 X 30 CM	23 X 38 CM
Carts on path only	SG09501	SG09901
Drop Area	SG09502	SG09902
Ground under repair	SG09503	SG09903
Keep carts 30' from green	SG09504	SG09904
No carts	SG09505	SG09905
Please repair ball marks	SG09506	SG09906
Replace divots	SG09507	SG09907
Customized sign	SG09598	SG09998

GREEN LINE FAIRWAY SIGNS DOUBLE SIDED

	15 X 30 CM	23 X 38 CM
Carts on path only	SG09551	SG09951
Drop Area	SG09552	SG09952
Ground under repair	SG09553	SG09953
Keep carts 30' from green	SG09554	SG09954
No carts	SG09555	SG09955
Please repair ball marks	SG09556	SG09956
Replace divots	SG09557	SG09957
Customized sign	SG09599	SG09999

- INFORMATION SIGNS -



FAIRWAY SIGNS & DIRECTION ARROWS

- Available in traditional classic green, tan and yellow.
- Cast aluminium signs with easy-to read decals on both sides.



Fairway sign green / tan
23 x 11 cm

FAIRWAY SIGN 23 X 11 CM	GREEN / WHITE
Carts On Path Only	SG09151
Drop Area	SG09152
Ground Under Repair	SG09153
No Carts	SG09155
Please Repair Ball Marks	SG09156
Replace Divots	SG09157
Plain Green	SG09158



Direction arrow green / white
28 x 6 cm

DIRECTION ARROWS GREEN / WHITE		
	28 X 6 CM	38 X 10 CM
Carts	SG10150	SG10050
Next Tee	SG10152	SG10052
Golf Cars	SG10154	SG10054
No. Tee		SG10056
Buggies	SG10160	SG10060
Trolleys	SG10162	SG10062
Plain Green	SG10158	SG10058



Direction arrow white / yellow
28 x 6 cm

DIRECTION ARROWS WHITE / YELLOW		
	28 X 6 CM	38 X 10 CM
Carts		SG10000
Next Tee	SG10102	SG10002
Golf Carts	SG10104	



LAMINATED DIRECTIONAL SIGNS

- These laminated signs are routed, wheater resistant, extremely durable and affordable.
- Available in yellow and green.
- Size: 25,4 x 14 cm.

CAPITONS AVAILABLE FOR LAMINATD DIRECTIONAL SIGNS:

	GREEN	YELLOW
Ground Under Repair	MT681100	MT681200
Tee Area Closed	MT681101	MT681201
Keep Carts On Path	MT681102	MT681202
Drop Area	MT681103	MT681203
Drop Zone	MT681104	MT681204
Putting Green Closed	MT681105	MT681205
Carts → (Double sided)	MT681106	MT681206
Next Tee → (Double sided)	MT681107	MT681207
No Carts	MT681109	MT681209
Native Area	MT681110	MT681210
Native Area No Carts	MT681111	MT681211
Please Repair Ball Marks	MT681112	MT681212
No Carts Past Here	MT681113	MT681213
No Chipping	MT681114	MT681214



- INFORMATION SIGNS -

STAINLESS STEEL MESSAGE HOLDER

- A classy and durable solution for any message you would like to put on the tee.
- Made of stainless steel.
- Can also be used as contest indicator.
- Holds 20 x 15 cm cards (not included).

Stainless steel message holder **PC19210**



Hinged lid provides easy access to message card.

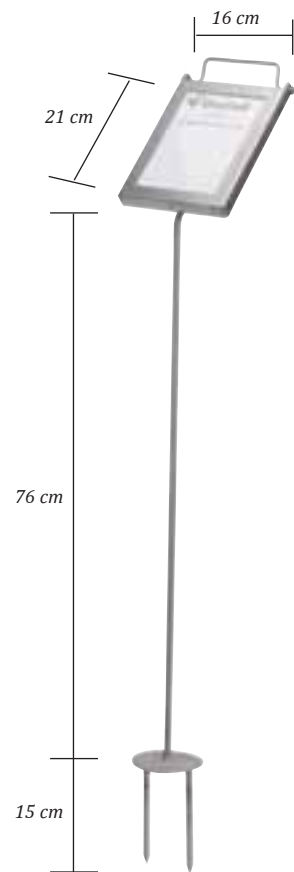

30 X 30 CM INFORMATION SIGN

- Single-sided aluminium sign.
- Silk-screened with weather-resistant ink.
- Size: 30 x 30 cm.

Aluminium sign white with dry erase marker **SG10330**
Order Sign post separately.



SIGN POST

- Available in two sizes: 46 and 102 cm.
- Square steel tubing finished in black powder coating.
- Fits any standard or custom 30 x 30 cm sign.

Sign post 46 cm **SG10418**
 Sign post 102 cm **SG10400**

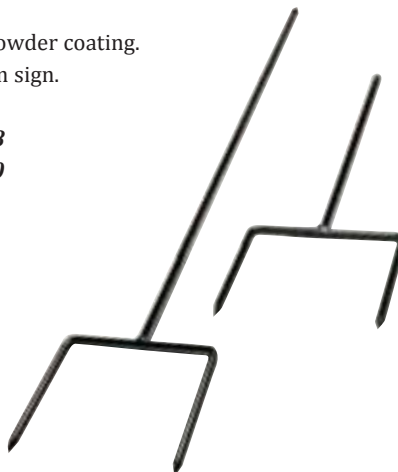

- RAKES -



PATISSON SCREW-FIT STANDARD RAKE

- Fibreglass 120 cm handle complete with factory fitted grip.
- Handle screw-fits into head.
- Colour: green.
- Head size: 58 cm.
- Packed: 10 per box.

Head only ***PA507505T***
Screw-fit handle ***PA507507G***

BUNKER RAKE HANDLE DECALS

Direct players to leave rakes in or out of bunkers.
Thirteen to a set; kiss-cut for easy use.

“Leave Rakes In Bunkers” ***PA965-1***
“Leave Rakes Out of Bunkers” ***PA965-2***



THE JOST BUNKER RAKE

- Light & flexible.
- Supplied with wooden handle, 170 cm.
- Head size: 63,5 cm.

Jost rake complete ***DU36001***
Jost handle only ***DU36021***
Jost head only ***DU36002***

RAKE BEARER

- Yellow powder coat finish.
- Ideal for keeping your rake in place and your rake handle clean.
- Packed: 6 per box.

Bearer ***DU36003***

- RAKES -



PATTISSON PRO RAKE

- Round edges on each end for a clean finish.
- High-density lightweight polyethylene head.
- Extra strong – guaranteed ‘no splinter’- composite handle.
- Two handle sizes and two head sizes.
- Heads can also be used in combination with the Gold Rake handle.
- Heads & handles packed per 25.

Pattissoon Pro complete 43 cm, 137 cm handle **P507650**
 Pattissoon Pro complete 43 cm, 183 cm handle **P507651**

Pattissoon Pro complete 63 cm, 137 cm handle **P507660**
 Pattissoon Pro complete 63 cm, 183 cm handle **P507661**

Pattissoon Pro rake head 43 cm **P507665**
 Pattissoon Pro rake head 63 cm **P507666**
 Pattissoon Pro green composite handle 137 cm **P507655**
 Pattissoon Pro green composite handle 183 cm **P507656**



PATTISSON TOUR RAKE

- Economical, ultralight rake - one-handed use.
- Lightweight, high-density polyethylene head.
- Quick screw-on assembly.
- Available with 120 cm aluminum handle or a yellow or green plastic coated steel handle.
- Packed per 12.

Pattissoon Tour rake with aluminum handle **P507611**
 Pattissoon Tour rake with yellow handle **P507600**
 Pattissoon Tour rake with green handle **P507610**

Pattissoon Tour rake head only **P507601**
 Pattissoon Tour rake aluminum handle only **P507616**
 Pattissoon Tour rake yellow handle only **P507605**
 Pattissoon Tour rake green handle only **P507615**



- RAKES -



GOLD RAKE

- Bend shape keeps handle from the ground.
- Aluminum handle.
- Head size: 58 cm.



Gold Rake complete
Gold Rake, head only
Gold Rake, handle only

DU36008
DU36011
DU36012



PATTISSON PRO RAKE

- Round edges on each end for a clean finish.
- High-density lightweight polyethylene head.



Pattison Pro rake, 43 cm, head only
Pattison Pro rake, 64 cm, head only
Gold Rake handle

P507665
P507666
DU36012

- RAKES -

All below rake heads fit the Gold Rake handle.



ACCUFORM ACE II

- Short-tooth tines with tapered sides for smooth finish in bunker.
- Patented round back with tapered sides.
- Made of impact resistant PE – superior Accuform Quality.
- Available in 43 cm and 64 cm width.

Accuform ace II head, 43 cm, head only

PA990-01

Accuform ace II head, 64 cm, head only

PA995-01

Gold Rake handle

DU36012

End Cap

DU36017



ACCUFORM ACCUCURVE

- Short-tooth tines with curved back.
- Patented 2-sided profile.
- Made of impact resistant PE – superior Accuform Quality.
- Head size: 31 cm.

Accuform Accucurve Head, 31cm, head only
Gold Rake handle

PA997-01

DU36012



TOURSMOOTH II

- Short-tooth's tines with curved back.
- Reinforced high- impact plastic head.
- Head size: 38 cm.

Tour smooth II, 38cm, head only
Gold Rake handle

SG11801

DU36012



- RAKES -



THE ACCUFORM® ACE II

The rake that started the revolution, the ultra-lightweight, patented Accuform® Ace.

- The first rake with short-tooths tines on one side for raking and a special surface for smoothing. It eliminates bad lies in the bunker.
- One-piece head, constructed of impact-resistant high-density polyethylene.
- Available in 43 cm width and the tour-popular 64 cm width.
- The most widely recognised bunker rake in the world.
- Preferred by top superintendents worldwide.

ACCUFORM® ACE II 43 CM

- Weight: 0,9 kg.



- | | |
|-------------------------------------|-----------------|
| With 137 cm green honeycomb handle | PA990-1 |
| With 137 cm green aluminium handle | PA990-5 |
| With 137 cm green ProTect handle | PA990-8 |
| With 137 cm sienna brown alu handle | PA990-10 |
| Head only | PA990-01 |

ACCUFORM® ACE II 64 CM

- Weight: 0,9 kg.



- | | |
|-------------------------------------------|-----------------|
| With 137 cm green honeycomb handle | PA995-1 |
| With 137 cm green aluminium handle | PA995-5 |
| With extra long handle, 240 cm | PA995-7 |
| With 137 cm green ProTect handle | PA995-8 |
| With 183 cm green ProTect handle | PA995-9 |
| With 137 cm sienna brown aluminium handle | PA995-10 |
| Head only | PA995-01 |

Rake heads fits Gold Rake handle of page 162.

- RAKES -
STANDARD
GOLF COMPANY



TOUR PRO

When mediocrity isn't an option and only perfection will do, turn to the Tour Pro Bunker Rake. No other bunker rake can make smooth, level, playable surfaces like the Tour Pro.

- Made from a stronger and lighter-weight material.
- 51 cm and 63 cm heads ensure tracks are covered with minimum effort, while pioneering design generates tournament quality surfaces.
- When durability is a must, the Gator grip handle is the best option. Available in both 152 cm and 183 cm lengths.
- A single self-tapping screw (included) is all you need for assembly.
- Packed 12 per box only the curved handles are packed per 6.

51 CM TOUR PRO HEAD

- With 163 cm green aluminum curved handle **SG11750**
- With 137 cm green composite handle **SG11700**
- With 137 cm green aluminum handle **SG11760**
- With 152 cm green Gator grip handle **SG11720**
- With 152 cm brown Gator grip handle **SG11730**
- Head 51 cm only **SG11701**

63 CM TOUR PRO HEAD

- With 152 cm green Gator grip handle **SG11790**
- With 183 cm green Gator grip handle **SG11770**
- With 183 cm brown Gator grip handle **SG11780**
- Head 63 cm only **SG11771**

- RAKES -



Par Aide offers a full line of replacement handles and grips as well as decals with rake placement instructions.

- Honeycomb core offers greater strength.
- Hollow design is lighter.
- Improved UV protection for longer lasting.



FIBREGLASS HONEYCOMB HANDLE

- Fibreglass honeycomb handle offers greater strength.
- Fibreglass handles contain improved UV protection to maximize handle life.



PROTECT HANDLE

- ProTect handle features a thermoplastic coating to dramatically decrease the chance of fibreglass splinters.



POWDER COATED ALUMINIUM

- Powder coated aluminium for a non fibreglass option.
- Lightweight yet strong.
- Now available in brown or green.



BUNKER RAKE HANDLES AND GRIPS

HANDLES

- Green honeycomb fibreglass handle with rubber grip (137 cm)
- Green ProTect (thermoplastic coated) handle (137 cm)
- Green ProTect (thermoplastic coated) handle (183 cm)
- Green powder coated aluminium handle (137 cm)
- Brown powder coated aluminium handle (137 cm)

- PA972-1*
- PA972-8*
- PA972-9*
- PA972*
- PA972-10*

GRIPS

- Rubber grip, package of 10

- PA974-10*

- RAKES -



LOOK TO STANDARD GOLF FOR THE BEST RAKES IN THE BUSINESS

Whether you're looking for strength or affordability – or both, there's no reason to look any further. Our sand bunker rakes are specifically designed for golf course use. And there's a perfect rake for every need and budget!

TOUR-LITE™ RAKE

The Tour-Lite™ rake is designed with the same curvature and teeth as our popular Tour Smooth™ rake, but lighter in weight for easy, one-handed use. It rakes and smoothes in one, easy motion.

The ultralight handle and head are threaded for quick assembly. No screws and no cracked handles.

- High-density polyethylene head moulded from recycled materials.
- Ultralight plastic-coated steel handle.
- Handle grip cap.
- Weight: 0,53 kg.
- Size handle: 137 cm.
- Size head: 38 cm.
- Packed: 12 per carton.

- Complete rake with yellow ultralight handle
- Complete rake with green ultralight handle
- Tour-Lite™ head only
- Yellow ultralight steel handle only
- Green ultralight steel handle only

- SG12350**
- SG12375**
- SG12301**
- SG12305**
- SG12306**



ECONOMY RAKE

- Economical in price.
- Available with wooden handle.
- Bright yellow or green handle.
- Weight: 0,42 kg.
- Size wooden handle 122cm.
- Size head: 38 cm.
- Packed: 12 per carton.

- Complete rake with yellow wooden handle
- Complete rake with green wooden handle

- Economy rake head only
- Yellow wooden handle only
- Green wooden handle only

- SG11600**
- SG11625**
- SG11601**
- SG11605**
- SG11626**



- RAKES -



15" TOUR SMOOTH II RAKE

Time-tested design and performance of the Tour Smooth bunker rake just got an upgrade. Improved rake assembly and the addition of the exclusive Gator grip handle makes the Tour Smooth II complete.

- Smoothes both fine and course sand into perfect playing conditions quickly and easy.
- A single self-tapping screw (included) is all you need for assembly.
- Weight: 0,83 kg.
- Size handle: 137 cm.
- Size head: 38 cm.
- Packed: 12 per carton.

Complete rake with green aluminium handle	SG11860
Complete rake with green composite handle	SG11800
Complete rake with green Gator grip handle	SG11820
Complete rake with brown Gator grip handle	SG11830
Complete rake with green aluminium curved handle	SG11850

Tour Smooth II 15" head only	SG11801
Bolt assembly	SG11502
Natural aluminium handle only	SG11205
Yellow aluminium handle only	SG11515
Green aluminium handle only	SG11516
Tan composite handle only	SG11214
Green composite handle only	SG11216



Rake heads fits Gold Rake handle of page 162.

COMPOSITE HANDLES

Composite handles for the Tour Smooth® and Duo-Rake™ lines are stronger than fibreglass, resist fading in sunlight and totally end the nightmare of fibreglass splinters in players' hands. They'll hold up without breaking, fading, or splintering with normal use. Available in tan, yellow and green.

- BUNKER STAMP & RAKES -

BUNKER STAMP

- Impress your golfers by displaying a message or logo in the bunker.
- Rubber mould easily gets placed in the bunker and leaves a perfect image by only stepping on it.
- Can be used year after year.
- Price based on the size of the stamp.

Thanks for Raking (0,20 m2)	DU36100
Bunker stamp Small (0,28 m2)	DU36101
Bunker stamp Medium (0,55 m2)	DU36102



BUNKER DEBRIS SIEVE

Want your bunkers to look better and play better? Quickly and easily clear rocks, leaves, twigs and other debris from bunkers using the Bunker Debris Sieve. Simply use it like a rake by dragging it through your bunkers.

- Sand sifts through the openings leaving debris trapped in the basket.
- Head size: 48 cm.
- Wooden 183 cm handle.



With 1,30 cm openings	SG29325
With 0,64 cm openings	SG29350

DEBRIS RAKE

- Great for removing pine needles and as a replacement for traditional bunker rakes.
- Gusseted heads adds extra strength for demanding locations such as waste areas.
- 23 cm head is perfect for maintaining shrubs, flower beds or any other tight areas.
- Mounts to 152 cm padded fibreglass handle for maximum strength, reach and comfort.
- Packed per 2 in a box.

Debris rake 53 cm	SG11300
-------------------	----------------

**STANDARD
GOLF COMPANY**



- SHOE CLEANERS -



SQUARE PATTERN BOOT WIPER

- All steel frame complete with scrapers.
- Four replaceable brushes.
- Ideal in any location.
- Wide stable base for easy use.
- Zinc-passivated prior to powder coating to provide excellent protection for many years of outdoor use.
- Side brushes to clean sides of shoes as well as base.
- Brushes can be easily cleaned or replaced.

P706907

Square pattern replacement brushes

Set of 4

P707908



DUCHELL SHOE BRUSH

- Green, powder coated heavy duty shoe brush.
- For superb cleaning of your golf shoes.
- Complete with wooden knob.

Duchell shoe brush **DU49413**

Replacement bottom brush **DU49414**

Replacement side brush, set of 2 **DU49415**

Replacement wooden knob **DU49417**

- SHOE CLEANERS -



PORTABLE SPIKE BRUSH STAND

It offers the stability and cleaning effectiveness of a fixed-position brush stand, and yet you can move it to wherever it's needed.

- Patented design features base brushes and side brushes to thoroughly clean shoes.
- Holds steady on hard surfaces with integral rubber pads; spikes available to secure turf.
- Hunter Green and Medium Grey models available.
- Includes one set of message decals.
- Weight: 26,5 kg.

Brush stand, Hunter Green **PA512-11**
 Brush stand, Medium Grey **PA513-11**

Turf mounting spikes for brush stands **PA321-3**
 (set of 3)

Extra sets of usage decals (set of 3) **PA517**
 "Thank you for wearing alternative spikes"
 "Please clean spikes before entering"
 "Thank you for cleaning your shoes"



DELUXE SCRUSHER AND SCRUSHER

- Three separate bottom brushes now with softer, longer-lasting nylon bristles.
- Two side brushes with gentler bristles that don't scratch the sides of shoes.
- Cleans bottoms and side at the same time.
- The wider design of the Deluxe Scrusher offers more stability and extra space between lower bristles to prevent buildup.
- UV, environmentally safe, powder-coated finish included on the Deluxe model.
- Replaceable brushes.
- Optional equipment: 15 cm stakes for anchoring the Scrusher in asphalt, 46 cm stakes for anchoring the Scrusher in turf.

Scrusher **SG14100**
 Deluxe Scrusher **SG14000**

MOUNTING STAKES

Asphalt mounting stake, 15 cm **SG14106**
 Turf mounting stake, 46 cm **SG14124**

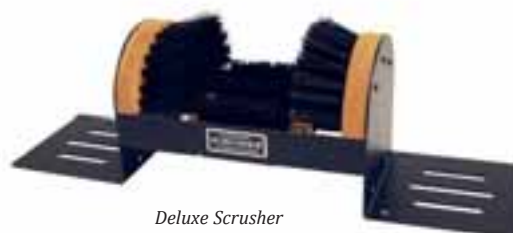

- SHOE CLEANERS -



FLOOR MOUNT COMBINATION

- Weight: 1,35 kg.

Alternative brushes *PA549-11*



SINGLE PIPE MOUNT SPIKE BRUSH

- Weight: 1,35 kg.

Alternative brushes *PA552-11*



DOUBLE MOUNT SPIKE BRUSH

- Weight: 2,25 kg.

Alternative brushes *PA553-11*



BASE BRUSH - fits all models

Alternative spikes *PA554-11*



SIDE BRUSH - fits 549, 512 & 513 models

Side brush *PA548*



PIPE MOUNT BLACK CLAMP

With hardware *PA552-3*

- SHOE CLEANERS -



TECHNOBROSS STAINLESS STEEL SHOE CLEANER

- All metal components made of stainless steel.
- Belt driven brush for smooth and quiet operation.
- Dual starter button for extra safety.
- Large dirt collection tray on sliders for easy emptying.
- Automatic overload switch off.
- Size: 58 (W) x 66 (L) x 100 (H) cm.
- Weight: 40 kg.

Technobross

DU49426



PATISSON GOLF SHOE VALET

- The quickest, cleanest and most effective way to remove mud, dirt and debris from your shoes and buggy wheels using compressed air.
- Casing powder coated to help resist corrosion.
- Large sliding tray for easy removal of dirt.
- Quiet and safe operation.
- Easily cleaned stainless steel construction.
- Two replaceable airguns.
- Size: 116 (W) x 106 (D) x 92 (H) cm.
- Weight: 187 kg.

Golf shoe valet

DU49419



- CLEANING SYSTEM -



ZELUP CLEANING SYSTEM

The Zelup cleaning system is a patented 2 in 1 cleaning and drying system for clubs, shoes and trolleys.

When the double trigger gun is locked in its first position it acts like a traditional spray gun attachment; when fully locked it becomes a vaporizing spray that propels very fine water drops.

The unique defragmentation system uses only 0,25 to 1 litre of water per minute (which is up to 40 times less than traditional systems!) and allows perfect cleaning and drying with only one gun.

The kit comes with a connection box, hose and spray gun with brush and needs to connect to a small compressor (not included) & water supply.

The guns are supplied in 2 versions; the heavy duty (industrial version) in aluminium and the country club version in polycarbonate.

KIT ZELUP SPRAY INCLUDING CONNECTION BOX + HOSE + GUN + BRUSH - STICK AND BODY IN ALUMINIUM.

Zelup Kit with 2 metre hose	DU49432
Zelup Kit with 2,5 metre hose	DU49433
Zelup Kit with 3 metre hose	DU49434

KIT ZELUP SPRAY INCLUDING CONNECTION BOX + HOSE + GUN + BRUSH - STICK AND BODY IN POLYCARBONATE.

Zelup Kit with 2 metre hose	DU49436
Zelup Kit with 2,5 metre hose	DU49437
Zelup Kit with 3 metre hose	DU49438



ZELUP ACCESSORIES:

Z-Box, 100% Stainless steel construction - elegant solution.

Size: (L) 45 x (W) 45 x (H) 40 cm.

Z-Box (without Zelup Spray kit) - delivered flat packed

DU49439

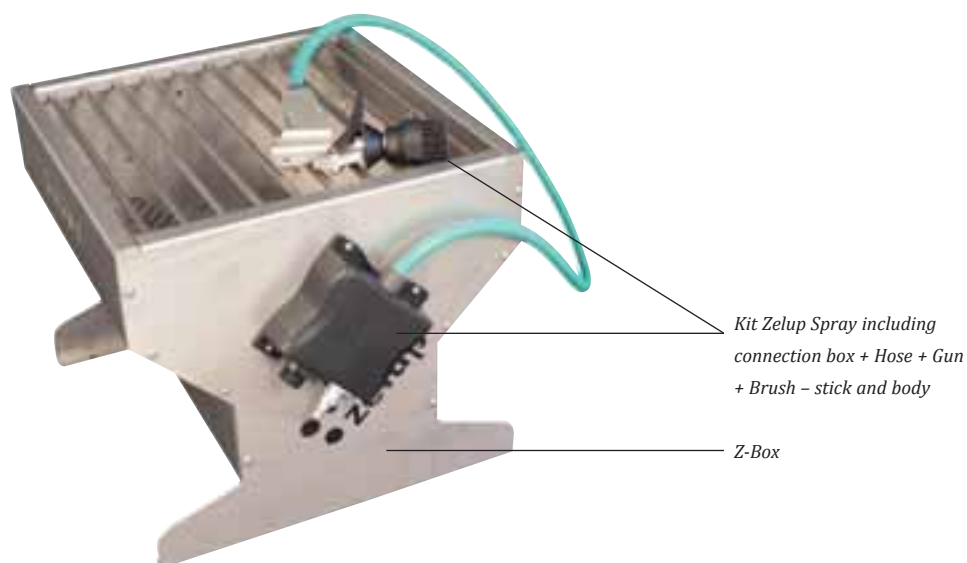

Z-STATION (NOT SHOWN)

1,5 x 1 metre galvanized frame with stainless adjustable feet

Z-Station prepared for Z-Box (Footprint for Z-Box)

DU49440

Z-Station not prepared for Z-Box (No Footprint for Z-Box - full grid)

DU49441

GREENKEEPER EQUIPMENT

Maintenance Tools	176
Marking Paint	177
Hole Cutters	178
Hole Cutter Parts	179
HIO Hole Cutter	180
HIO Hole Cutter Parts	181
Hole Cutters	182 - 183
Hole Accessories	184 - 187
Hole Painter	188 - 189
Whipping Poles	190
The Dewmaster	191
Drag Mats	192 - 193
Top Dressing	194
Core Cleaning & Cups Plugs	195
Accessories	196
Ball Mark Repair Tools	197
Specialty Tools	198
Specialty Rakes	199
Head Trimmer & Aeration Tools	200
Head Trimmer	201
Special Event Hole Cutters	202
Maintenance Tools	203
Repair Tools	204 - 207
Safety Net	205
Turfjector	206
Soil Testers	207



- MAINTENANCE TOOLS -



RT51000



RT51001



RT51002



RT51003



RT51004



RT51005

CABLE LAYING SHOVEL

Cable laying shovel with 70 cm wooden handle

RT51000

BORDER SPADE

Border spade with 70 cm wooden handle

RT51001

TREADED SPADE

Treaded spade with 70 cm wooden handle

RT51002

ROUND MOUTH SHOVEL

Round mouth shovel with 70 cm wooden handle

RT51003

EDGING KNIFE

Edging knife with 70 cm wooden handle

RT51004

GARDEN FORK

Garden fork with 70 cm wooden handle

RT51005

BORDER SHEARS

Border shears with 70 cm steel handles

RT51006



RT51006

GREENKEEPER EQUIPMENT

- MARKING PAINT -



PREMIER LINE MARKER PAINT

- The new Premier Line marker paint has replaced the Easyline paint.
- Environmentally friendly paint (non CFC).
- 750 ml per can.
- Carton: 6 cans - price per can.

Premier Line white	P807090W
Premier Line yellow	P807090Y
Premier Line red	P807090R
Premier Line blue	P807090B
Premier Line orange	P807090O

Two wheel applicator	P807092
Four wheel applicator	P807069
Hand applicator	P807070



MARKING PAINT

- Water based paint: reduces clogging and saves your grass from burning.
- Very high pigment concentration: vibrant turf marking.
- High quality resins offer a more consistent and long-lasting colour.
- Environmentally friendly.
- 500 ml per can.
- Sold in box of 12 cans - price per box.

White marking paint	PA12410
Red marking paint	PA12411
Yellow marking paint	PA12412
Blue marking paint	PA12413
Green marking paint	PA12414
Orange marking paint	PA12415



PAINT APPLICATOR

- Apply paint to your turf surfaces easily and generously!
- The paint applicator is appropriate for longer, even, more continuous marking.
- Lightweight and easy to maneuver.
- Approximately 89 cm long.

Long handle marker paint applicator **PA12401**



DOUBLE BARREL PAINT APPLICATOR

- Paint bolder, more noticeable lines around your hazards and out of bounds.
- Angles the paint cans slightly to focus the spray for highly visible lines.
- A great tool when preparing for tournaments.

Double barrel paint applicator **PA12403**



- HOLE CUTTERS -



Suggested blade use: Inside sharpened for sandy soil, outside sharpened for heavier soil.



LEVER ACTION HOLE CUTTER

- A back-saving design that allows for easier plug extraction.
- Weight: 4,5 kg.

With scalloped blade, inside edge	<i>PA1001-1</i>
With scalloped blade, outside edge	<i>PA1001-2</i>
With straight blade, inside edge	<i>PA1001-3</i>
With straight blade, outside edge	<i>PA1001-4</i>
With scalloped blade, inside edge and bubble level	<i>PA1001-19</i>
With scalloped blade, outside edge and bubble level	<i>PA1001-29</i>
With straight blade, inside edge and bubble level	<i>PA1001-39</i>
With straight blade, outside edge and bubble level	<i>PA1001-49</i>



FOOT EXTRACTION HOLE CUTTER

- Turf plug is extracted by stepping down on foot plate.
- Weight: 4,5 kg.

With scalloped blade, inside edge	<i>PA1002-1</i>
With scalloped blade, outside edge	<i>PA1002-2</i>
With straight blade, inside edge	<i>PA1002-3</i>
With straight blade, outside edge	<i>PA1002-4</i>
With scalloped blade, inside edge and bubble level	<i>PA1002-19</i>
With scalloped blade, outside edge and bubble level	<i>PA1002-29</i>
With straight blade, inside edge and bubble level	<i>PA1002-39</i>
With straight blade, outside edge and bubble level	<i>PA1002-49</i>

- HOLE CUTTER PARTS -



REPLACEMENT PARTS FOR HOLE CUTTER AND TURF MENDER

HOLE CUTTER BLADE PLAIN 10.8 CM

- Weight: 1,35 kg.
- Inside sharpened edge **PA1007-01**
- Outside sharpened edge **PA1007-02**

HOLE CUTTER SCALLOPED BLADE 10.8 CM

- Weight: 1,35 kg.
- Inside sharpened edge **PA1008-01**
- Outside sharpened edge **PA1008-02**

HOLE CUTTER PISTON

- Weight: 0,9 kg.
- Piston **PA1016**

LEVER ARM ONLY (both hole cutter and turf mender)

- Weight: 0,9 kg.
- Lever arm **PA1020**

PUSH ROD ONLY (both hole cutter and turf mender)

- Weight: 0,45 kg.
- Push rod **PA1021**

WOODEN HANDLE (both hole cutter and turf mender)

- Weight: 0,45 kg.
- Handle **PA1022**

MAIN SHAFT FOR LEVER ACTION HOLE CUTTER

- Weight: 2,7 kg.
- Main shaft **PA1023**

MAIN SHAFT FOR FOOT EXTRACTION HOLE CUTTER

- Weight: 2,7 kg.
- Main shaft **PA1024**

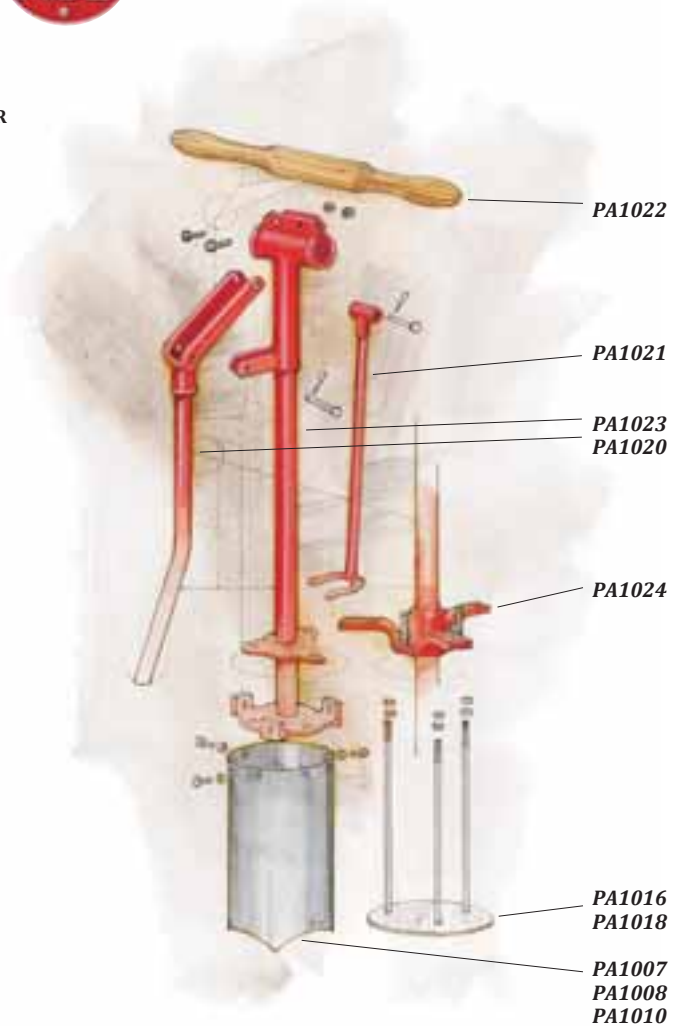

HOLE CUTTER HANDLE WITH BUILT-IN BUBBLE LEVEL

Made from turned hardwood with a recessed bubble level. Straight cup every time, regardless of who's using it – from the novice hole cutter to the experienced veteran. Optional item for all Par Aide hole cutters and fits more major brands. See page 180 for HIO bubble level. Weight: 0,9 kg.

Wooden handle with bubble level **PA1029**



REPLACEMENT BLADES

Straight blade 10,8 cm sharpened
 Inside **PA1007-01**
 Outside **PA1007-02**
 For all Par Aide hole cutters except the HIO-cutter.

REPLACEMENT BLADES

Scalloped blade 10,8 cm sharpened
 Inside **PA1008-01**
 Outside **PA1008-02**
 For all Par Aide hole cutters except the HIO-cutter.



- HIO HOLE CUTTER -



Suggested blade use: Inside sharpened for sandy soil, outside sharpened for heavier soil.

HIO HOLE CUTTER

- Perfectly round holes with clean edges.
- Easy on arms and shoulders - no twisting required.
- Achieve uniform hole depth.
- Powerful action works great on clay-bases “push up” greens.
- Saves time.

HIO HOLE CUTTER

With inside sharpened blade **PA1003-1**
 With outside sharpened blade **PA1003-2**

REPLACEMENT BLADE

Inside sharpened blade **PA1009-01**
 Outside sharpened blade **PA1009-02**

See a product video at www.duchell.com



1. Place HIO Hole Cutter in desired cup location.

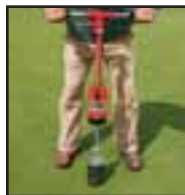

2. Remove pin. Lift handle and hammer actions drives cutter into the ground.



3. HIO Hole Cutter cuts holes with one plug, every time.



4. HIO Hole Cutter leaves a perfectly round clean hole.



HIO BUBBLE LEVEL

This optional item for the HIO Hole Cutter assures a straight cup every time. It fits all existing HIO hole cutters, simply attaching through the two bolts that hold the handle in place.

PA1028

- HIO HOLE CUTTERS PARTS -



HIO HOLE CUTTER PARTS

- | | |
|-------------------------------------|------------------|
| 1. Two-piece steel handle | PA1003-21 |
| 2. Rubber grip (pair) | PA1003-9 |
| 3. Locking pin, spring & ball kit | PA1003-22 |
| 4. Outer tube (complete) | PA1003-7 |
| 5. Ejecting handle | PA1003-8 |
| 6. Ejecting Rod | PA1003-10 |
| 7. Cleat | PA1003-16 |
| 8. Rope | PA1003-17 |
| 9. Rubber Ring | PA1003-13 |
| 10. Triangle Plate | PA1003-26 |
| 11. Inner Tube (not shown) | PA1003-25 |
| 12. Piston (not shown) | PA1017 |
| 13. Stop ring & pin kit (not shown) | PA1003-23 |

- HOLE CUTTERS -



- Hole cutter replacement parts
- Different shells for different soil conditions.
 - Inside sharpened blades compact loose soil into the cutter for better dirt transfer.
 - Outside sharpened blades are better for heavier soils and are more easily sharpened.



MAGNUM HOLE CUTTER

Our Tour-Cut™ delivers a clean, precise cut each and every time.

- Year-after-year, our most popular model.
- Field tested and proven for all soils...with flying colours.
- Smooth lever action.
- Full selection of cutter shells to match your conditions.

Straight shell, sharpened inside **SG28960**

Scalloped shell, sharpened inside **SG28970**

Scalloped shell, sharpened outside **SG28980**

PRO II HOLE CUTTER

Since every course is different, we designed our Pro II hole cutter shells so you can order one that's right for your conditions.

- Hot rolled tubing with carbon steel shaft and sturdy ash handle.
- All parts are interchangeable and replacable.
- Foot ejector only.
- Adjustable depth collar.
- Scalloped shell has four cutting points.
- Weight: 4,5 kg.

With 10,8 cm straight shell, inside edge **SG28700**

With 10,8 cm scalloped shell, inside edge **SG28800**

With 10,8 cm scalloped shell, outside edge **SG28801**

MAGNUM AND PRO II REPLACEMENT SHELLS

Straight, inside edge **SG28927**

Scalloped, inside edge **SG28952**

Scalloped, outside edge **SG28953**



Straight Shell



Scalloped Shell

GREENKEEPER EQUIPMENT

- HOLE CUTTERS -



PATISSON PREMIER HOLE CUTTER

- Pattison's most successful hole cutter.
- 3 ring stability complete with heavy duty hardened steel blades.
- Enlarged bottom ring for extra stability and eliminating the need for a hole cutter board.

Premier Hole Cutter **P605608**

Replacement blade, single **P605607**



TURFMASTER HOLE CUTTER

- Razor-sharp outside sharpened blades prevent soil compaction and minimize impact on the putting surfaces and fragile root systems.
- Use rubber mallet to drive in the blade halves.
- Weight: 4,5 kg.

Turfmaster hole cutter **SG28000**

TURF MASTER REPLACEMENT PARTS

Replacement blade, single **SG28002**



PATISSON HEAVY DUTY HOLE CUTTER

- Dual, height adjustable handles for extra stability and easy guiding.
- Heavy duty case hardened steel blades.
- Solid design construction for extra durability.

Premier heavy duty hole cutter **P605609**

Replacement blade, single **P605610**



MALLET

Rubber mallet

DU37031



- HOLE CUTTING ACCESSORIES -



PATTISSON CUP SETTER ALUMINIUM

Cast aluminium with powder coated finish. The redesigned Cup Setter now sets cups an extra 3 mm below the surface of the green. In total 2,82 cm.

- Weight: 0,9 kg

CA29450



CUP SETTER PLASTIC

- Automatically set the cup 2,5 cm below the surface of the green as specified by the USGA.
- Set it, step on it and lift it out.
- Flattens and smooths crowning caused by hole cutters.
- Minimizes damage to the rims of aluminum cups.
- Weight: 0,2 kg.

SG30100



CUP AUGER

- Using this tool is the best way to achieve consistent cup depth on every green.
- Do it in 3 steps:
 1. Cut the new hole with any cup cutter.
 2. Insert the Cup Auger and turn until collar rests on turf.
 3. Remove Cup Auger and reuse removed soil.

MT655661



- HOLE CUTTING ACCESSORIES -



CUP PULLER

New design features longer rod and rubber handle for increased leverage and comfort. Plated steel construction. Three-hook design pulls cup out of hole straight and with ease, with no damage to turf.

- Weight: 0,45 kg.

PA1032



**STANDARD
GOLF** COMPANY

CUP HOOK

- Simple and easy way to remove any style cup.
- Size: 29 cm long
- Weight: 0,16 kg.

SG33200



CUP SAVER

The Cup-Saver is the newest tool to help keep your cups looking great longer.

- Made of durable, molded plastic
- The cone shaped design features an easy-to-grab stem.
- Perfect for use when painting the hole above the cup or when topdressing or applying chemicals.
- Sold per set of 5.

PA1073



Before topdressing.



Painting cups..



Applying chemicals..

- HOLE CUTTER ACCESSORIES -



HOLE CUTTER CARRIER

Keep your hole cutter within easy reach while saving space in your utility vehicle. It mounts in the bed of any maintenance vehicle, allowing upright or angled transport of any hole cutter. The carrier also protects the blade and body, while keeping the vehicle bed more organized. Durable steel construction with mounting hardware included.

PA1011



Every hole cutter fits on this carrier.



CREW CADDY

- The Crew caddy conveniently organizes your greens tools, keeping everything within reach.
- Saves time by organizing greens tools and allowing you to carry all your tools in one hand.
- Ergonomically shaped.
- Smooth bottom won't damage or mark green.
- Features individual compartments for organizing tools, includes hole cutter straps, water bottle, removable soil container.

PA1038

- HOLE CUTTER ACCESSORIES -



HOLE TRIMMING SCISSORS

P607613



HOLE CUTTER BOARD

Marine-ply hole cutter board (18 mm)

P606614



HOLE CUTTER GUIDE

Made from highly durable ABS plastic. Place on green when cutting cup hole to eliminate heel marks, minimize raised hole edges and encourage a straight cut.

- Weight: 3,6 kg.

PA1030



DEPTH GAUGE

Unique single set screw design allows for easy locating, straightening and tightening. Cast aluminium and anodised black, fits all hole cutters.

- Weight: 0,45 kg.

PA1034



SHARPENER

- Keep shells sharp for easier cuts and precision-cut hole edges.
- Works with scalloped or straight shells, inside our out side.

SG28400



- HOLE PAINTER -



360° HOLE PAINTER

The 360° Hole Painter is an innovative tool that paints the top 2,5 cm. above the cup bright white using a unique nozzle that sprays 360° degrees all at once.

- Simple and easy to use.
- No rotating of the can is necessary.
- No “shadowing” of the paint.
- No dripping on the cup or overspray on the green.
- Provides a consistent, professional finish every time.
- Greatly increases visibility of the cup.
- Patent pending.

360° degree Hole paint, box of 12. **PA910**

360° degree Hole Painter tool **PA911**

includes 3 aluminium cup shields
Aluminium replacement shields (set of 3) **PA911-1**

Plastic replacement shields (set of 10) **PA911-2**

See a product video at www.duchell.com



1. Place cup shield over regulation-sized cup.



2. Place painting tool over hole.



3. Insert spray can into center of painting tool and simply push down on the can 3-4 times. No rotating is necessary.



4. The 360° Hole Painter leaves a professional, consistent finish every time.



5. Place rag over nozzle and press to clear excess paint from nozzle after each hole is painted.

- HOLE WHITENER -



PATTISSON POT PAINTER

- Simple operation, press and turn.
- All in less than 4 seconds.
- Easy adjustable height for precision work.
- Holds Pot Painter 250 ml cans.
- Paint packed: per 12 cans.

Pattison Pot Painter **DU37100**
Pot Paint 250 ml each **DU37101**



HOLE-IN-WHITE PAINT

- For more visibility when putting from a long distance.
- Used on nearly all the European Tour events.
- Packed: per 12 cans.

Spray can Hole-In-White **DU3707**
Hole-in-White Marker tool **DU37071**



CUP RING

- For better visibility from a long distance.

Ring **DU44001**



- WHIPPING POLES -

WHIPPING POLES

Choose between two lightweight, durable whipping pole models for removing dew and worm casts from the green.

- Each whipping pole offers two-piece design, with a lightweight anodised aluminium handle.
- Each whipping pole has a durable 244 cm tapered fibreglass tip.
- On our original whipping pole, the handle and fibreglass tip are secured together by two thumb screws.
- On our E-Z Whip design, the fibreglass tip slides inside the handle during storage and transportation and easily extends out for whipping.



E-Z Whip: fibreglass tip slides in and out of handle (cut-away view).

E-Z WHIP WHIPPING POLE

- Weight: 1,35 kg.
- PA1060**

E-Z WHIP FIBREGLASS TIP

- Weight: 0,45 kg.
- PA1065**

E-Z WHIP HANDLE WITH GRIP

- Weight: 0,9 kg.
- PA1066**

Rubber grip
PA1067



Original Whipping Pole: handle and fibreglass tip are secured together by two thumb screws.

ORIGINAL WHIPPING POLE

- Weight: 1,35 kg.
- PA1040**

ORIGINAL FIBREGLASS TIP

- Weight: 0,45 kg.
- PA1045**

ORIGINAL HANDLE WITH GRIP

- Weight: 0,9 kg.
- PA1046**

Rubber grip **PA1047**
Thumb screw **PA1048-4**
Package of 4
Coupler for tip **PA1049**



Threaded end cap.



DU-WHIPPER

- Sweep away morning dew, worm casts and bunker sand instantly.
- Easy to handle. Even easier to transport.
- Telescoping fibreglass pole stretches 2 m to 5 m.
- Durable threaded cap.
- Weight: 0,9 kg.

SG34200



- THE DEWMASTER -



THE DEWMASTER

- A time saving product designed to remove dew from greens.
- Length brush: 300 cm.
- Strong aluminium dual grip handle.
- Heavy duty bracket joins the two 150 cm brushes.

The Dewmaster **P805004**



STANMORE TELESCOPIC TURFSWITCH

Whipping Pole **P006026**
Yellow Replacement rod **P807011**



THE FOLDING DEWMASTER

- A time saving product designed to remove dew from greens.
- Length brush: 300 cm.
- Strong aluminium dual grip handle.
- Easily folds together for efficient storage and transportation.

The Folding Dewmaster **P804004**



- DRAG MATS -

**STANDARD
GOLF COMPANY**



COCO FIBER DRAG MAT

- Spreads top dressing with a soft, smooth touch. Perfect for all playing surfaces.
- Tough, resilient fibers, 3 cm, bond to vinyl-reinforced backing.
- Smaller lighter-weight mat makes it easy for one operator to use.
- 3 mtr chain hooks up to any vehicle.
- Size: 1,2 m x 1,8 m.
- Weight: 29 kg.

SG53000



CORE BUSTER DRAG MAT

- Breaks up cores easier, faster & better.
- Made of durable polyethylene.
- Interlocking grid panels (50,8 x 50,8 x 5 cm) let you create your individual size.
- Durable, rust free and easy to store.
- Create your own size by adding panels, draw bars and hardware kits.

Core Buster Drag mat I **PA1081**
Weight 50,8 kg, size 406,50 x 152,4 cm (8 x 3 panels)

Core Buster Drag mat II **PA1080**
Weight 35,4 kg, size 254 x 152,4 cm (5 x 3 panels)

Individual panel **PA1080-10**
Weight 1,8 kg, size 50,8 x 50,8 cm

Draw Bar single section only **PA1080-12**
Hardware kit **PA1080-11**
Includes 4 eye bolts with washers and nuts & 4 quick clips.



Individual panel



Hardware kit



Draw bars



Easy installation

- DRAG MATS -



DRAG MAT

- All steel reversible dragmat used for levelling top dressing or sand surfaces.
- Size: 180 x 120 cm.

P806008

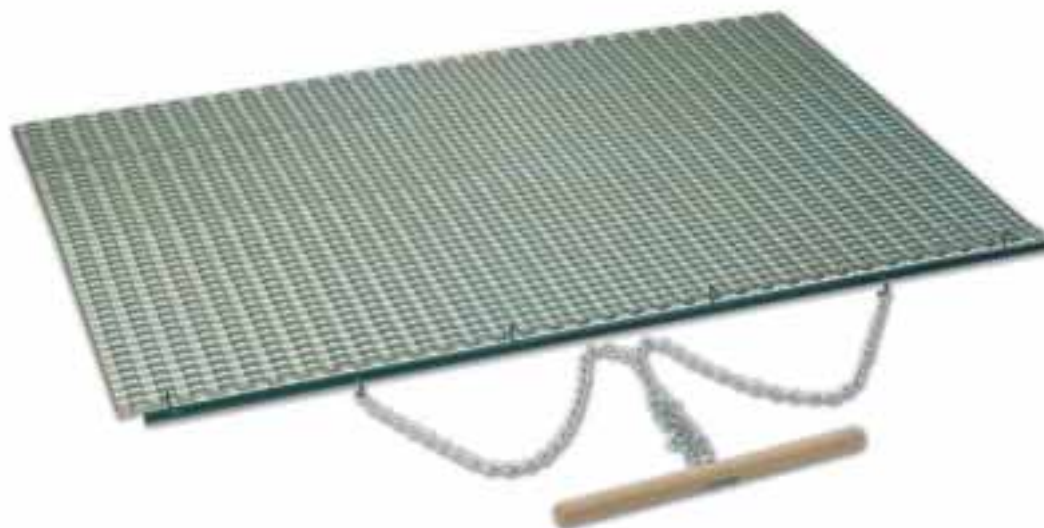

**STANDARD
GOLF COMPANY**

MAGNUM MONSTER BROOM

- Perfect for removing dew or worm casts from greens and tees.
- Makes short work of shop floors and tennis courts.
- Two rows of replaceable bristles — mounted to a giant 213 cm head with 102 cm handle.
- Soften broom action by simply removing a row of bristles.
- Weight: 6,7 kg.

SG72150



- TOP DRESSING -



LEVEL SPREADER

- Spread and smooth soil before seeding of planting.
- Must-have tool for practice tee repair.
- Handle: 183 cm.
- Size: 86 cm wide.

MT540580



LEVELAWN

- Distributes application materials.
- Removes stones from soil, breaks up small clods of sand or loam.
- Smooths soil for easy planting.
- Handle: 183 cm.
- Size: 76 cm wide.
- Weight: 3,6 kg.

SG29300

- CORE CLEANING & CUP PLUGS -



CORE HOG

- Time saving and streamlined way to clean cores from greens.
- Plows all cores in its path into a neat pile right off the green.
- PA1075: compatible with Toro 1000, Jacobsen PGM & John Deere 220, 220A and 180A.
- PA1076: compatible with Toro Flex 21.
- Safe green contact with smooth plastic wear bars.
- Stainless steel hardware designed for long-lasting wear.
- Made of powder coated steel.



Core Hog with universal bracket
Weight 8,2 kg

PA1075

Core Hog only for Toro Flex 21
Weight 9,0 kg

PA1076



Front



Back



With Toro Flex 21 Bracket
PA1076

CUP PLUGS

- Made from durable, lightweight, weather-resistant foam material.
- Used when aerating greens to protect the integrity of the hole.
- Used when topdressing greens to keep sand from filling up cup hole.
- Can be left in holes during winter months.
- Aeration tines able to penetrate plug without pulling it out of the hole.
- Can be used 2 - 3 times.
- Sold per 9 pieces.

Regulation cup size, pack of 9 pcs

PA1070

Practice cup size, pack of 9 pcs

PA1071



- ACCESSORIES -



WEED WAND

- Precision chemical applications around flowerbeds, fragile planting and other tight areas.
- Lightweight, 92 cm wand is designed to minimize spills, and for easy refills.
- 2,5 cm diameter applicator tips precisely control chemical flow and eliminate overspray.

Weed Wand **SG29700**
 Replacement tips (5 per pack) **SG29701**



SWEET ROLL RAIL SYSTEM

- Multi-purpose system putting green system.
- Stimp meter without the 'bouncing ball' when it comes onto the green from a constant angle.
- Asses reliability and consistency of putting surfaces by repeatedly simulating the exact same put on the same surface.
- Can be used as a multifunctional training device.

Sweet Roll Rail System **DU37000**



STIMP METER

In 1935 Edward Stimpson, the Massachusetts amateur champion, developed what is now known as the stimp meter.

Stimp meter **DU37001**

Green Speed	Average length of roll (in feet)	
	Normal Play	Tournament Play
Fast	8.5	10.5
Medium Fast	7.5	9.5
Medium	6.5	8.5
Medium Slow	5.5	7.5
Slow	4.5	6.5

- BALL MARK REPAIR TOOLS -

ACCUFORM ACCUFIX

This affordable, light, easy-handling tool is designed to effectively repair ball marks in one motion. The rounded handle and rubber grip are comfortable to use with one hand. Simple push down over the ball and the spring-loaded head with stainless steel teeth will lift the turf back into a perfect playing surface.

Features include:

- 91 cm powder coated aluminum handle.
- Stainless steel teeth.
- Spring loaded head.
- Ergonomic handle.
- Rubber grip.

PA1092



GREENSAVER

Just position the Greensaver over a ball mark, thrust downward, let up on the handle and tap the area with your foot. Its eight fingers fix the ballmark so well, you can barely see it.

But use it for more than just ball marks; it quickly repairs damage from hoofed animals, vandals and more.

- Weight: 3,5 kg.

PA1090

See a product video at www.duchell.com



GREENKEEPER BALL MARK REPAIR TOOL

- Great time-saving, labor-saving tool for quick, near-flawless repairs on greens.
- 91 cm handle makes repairs fast and easy.
- Meticulously lifts dirt and grass into place in one motion.
- Weight: 1,8 kg.

SG27200



- SPECIALTY TOOLS -



Tending to the greens has never been easier than with these specialty tools from Accuform® by Par Aide. Each is specially designed to make caring for the greens easier and with our sturdy construction, they will stand up to daily use for years.

ROLLER SQUEEGEE

Squeegee is non-absorbent and recommended for drying greens and turf. Heavy duty ribbed frame construction, combined with wrap-around bracing, eliminates deflection when pressure is applied. Comes with a 152 cm bent powder-coated aluminium handle with 12,7 cm grip.

- Weight: 3,4 kg.

Squeegee 61 cm with aluminium handle **PA13220**
Squeegee 91 cm with aluminium handle **PA13224**



ACCUFORM® PLUG PUSHER

The specially designed 91 cm aluminium head is excellent for pushing aeration plugs off the green. Comes with sturdy wrap around bracing an 168 cm powder coated aluminium handle with 12,7 cm grip.

- Weight: 2,7 kg.

Plug Pusher with 66 cm aluminium handle **PA13240**



- SPECIALTY RAKES -



Bunker rakes and debris rakes see page 160-169.



Accuform® is one of the best names in the industry.

ACCUSMOOTH MAINTENANCE BUNKER RAKE

A patented original that rakes and smooths.

- Weight: 2,25 kg.
- Size head: 56 cm.



With 168 cm powder coated aluminium handle

PA13130

With 208 cm powder coated aluminium handle

PA13134

ACCUFORM® SCREENING RAKE

Designed for sifting, grading and screening stones and debris from sand or fine soil.

- Weight: 2,25 kg.



Screening rake 61 cm with 168 cm powder-coated aluminium handle

PA13120

Screening rake 91 cm with 208 cm powder-coated aluminium handle

PA13124

ACCUFORM® LANDSCAPE RAKE

Long round teeth for smooth, non-gouging raking action and a large striking edge excellent for grading.

- Weight: 2,25 kg.
- Size handle: 168 cm.



Landscape rake 61 cm with powder-coated aluminium handle

PA13110

Landscape rake 91 cm with powder-coated aluminium handle

PA13114

Landscape rake 122cm with powder-coated aluminium handle

PA13118

- HEAD TRIMMER & AERATION TOOLS -



POWERHEAD

- The most cost effective way to maintain sprinkler heads.
- A perfect cut around the sprinkler heads.
- Cleans and cuts in seconds.
- Frees valuable labour.
- Optimum use of water.
- Can be supplied for almost every size of sprinkler head.
- The perfect strimmer attachment!
- Packed per 10 pieces.

Powerhead 6,35 cm (2,5") **DU49809**
(to fit PGP/Hunter I-10/I-25, Rainbird 1800 and the T-Bird)

Powerhead 15,24 cm (6") **DU49810**
(to fit Toro 630/730/760 and any other 15,25 cm body)

Powerhead 16,51 cm (6,5") **DU49811**
(to fit Hunter/Legacy 520/550/600/650 and any other 16,50 cm body)

Powerhead 19,05 cm (7,5") **DU49812**
(to fit Toro 650/655/670/750/780 and any other 19,00 cm body)

Powerhead 25,40 cm (10") **DU49816**
(to fit Toro 690 and Rainbird 91DR & 91DS and also fits 10" valve boxes)

Powerhead fixing kit only **DU49820**



STANDARD GOLF CONCEPTS



HAND AERIFIER

- Choose solid or hollow tines; 5,7 cm penetration.
- Rugged steel construction.
- Core collector is built right into the base.
- 7.6 cm x 0.95 cm replaceable tines on 5 cm centers.
- Order body assembly and tine base assembly separately.

Body assembly only **SG29808**
Hollow tine base assembly **SG29803**
Solid tine base assembly **SG29805**



MILTONA



SPOT OVERSEEDER-SPIKER

- Perfect tool to prepare mid-sized areas for overseeding.
- 9 m2 can be prepared in less than 20 minutes.
- The 20 x 28 cm spike pad features 72, 0,6 cm diameter spikes, spaced on 2,54 cm center.
- Spring-operated ejection pad prevents tearing or lifting of turf.
- To use simply step of jump on pad to force spikes 1,27 cm to 1,91 cm into ground.
- All-steel construction will stand up to the most intense overseeding projects.

Spot Overseeder-Spiker **MT540560**

- HEAD TRIMMER -

TURBO TRIM RATCHETING TOOL

- Golf sprinkler head trimming just got easier!
- Finally, a unique tool designed and engineered to help you do the job like you never could before.
- Super heavy duty steel construction & powder coated finish.
- The only trimmer with a forward & reverse drive ratchet mechanism.
- Clean steady cut – saves time & energy.
- Pro ratchet system.
- Easy to use more accurate trim.
- Order tool and blades seperately.
- Cutting blades sizes: 7,78 cm (7"), 20,32 cm (8") and 27,9 cm (11").

TurboTrim ratcheting tool

UTTRT-100

TurboTrim 17,78 cm (7") blade

UTTRC-007

TurboTrim 20,32 cm (8") blade

UTTRC-008

TurboTrim 27,9 cm (11") blade

UTTRC-011



Replacement cutting blade 27,9 cm (11")



Replacement cutting blade 20,32 cm (8")



Replacement cutting blade 17,78 cm (7")



- SPECIAL EVENT HOLE CUTTERS -



38,1 CM EVENT CUP HOLE CUTTER

- To cut holes for 38,1 cm special event hole cups.
- The cutter has a piston for removing the very large plug.
- The blade is heat-treated steel to produce clean cuts every time.
- Cuts 9,5 cm deep.

38,1 cm event hole cutter - complete **PA1004**

Please see page 140 for matching hole cups.



20,2 CM EVENT HOLE CUTTER AND ADAPTER

- To cut holes for 20,2 cm special event hole cups.
- Choose the complete hole cutter or the adapter for use with an original Par Aide hole cutter.
- Adapter: just remove the regulation blade hole cutter piston and attach the adapter.
- This tool will also allow you to repair large patches of turf.
- Adapter includes all necessary hardware and 20,2 cm hole cutter piston.
- Cuts 8,9 cm deep.

20,2 cm event hole cutter - complete **PA1005**
Adapter **PA1012**



STANDARD
GOLF COMPANY

PRO II HOLE CUTTER

- Simple, economical and ready to cut.
- Hot-rolled tubing. Carbon steel shaft.
- Adjustable depth collar.
- Foot ejector.
- Available in 2 sizes: 15,2 cm and 20,2 cm.

15,2 cm event hole cutter - complete **SG28775**
20,2 cm event hole cutter - complete **SG28785**

- MAINTENANCE TOOLS -



ACCUFORM ACCUSEED

- The perfect spot seeding tool.
- The specially designed stainless steel spring loaded spikes puncture the turf 0,8 cm deep while dropping bent grass seed precisely into the holes, allowing for ideal seed to soil contact.
- Grass seed is easily filled into the black housing and is only released when the spring-loaded head compresses.
- There is minimal impact to the surface, due to the flat surface of the seed housing, which causes little disruption to play.

Accuform Accuseed

PA13270



Seed filled spikes extended.



Spikes retracted, leaving seed in holes.



Accuseed provides quick results.



QUICK-FILL BALL MARK ERASER

- Improve the appearance of greens damaged from ball marks.
- Erase ball marks instantly with a dash of green sand.
- Innovative design means one touch dispenses perfect amount of sand.
- No bending over, no getting down on your knees and no jamming.
- Dispensing mechanism designed for smooth, non-seizing operation.

Quick-fill ball mark eraser

MT550650



Divot mark before treatment.



Divot mark after treatment.



GREENS BULLIT

- Lightweight yet durable stainless construction.
- Adjustable collar so you can reach your desired depth.
- Use with Quick-Fill for best results.

Greens Bullit

MT550655



- REPAIR TOOLS -



TURF DOCTOR



- Invisible sod replacement.
- Finish patch areas without leaving holes or gaps (i.e. irrigation repair).
- Razor-sharp blades (4) secure 23 cm square-cut, wedge-shaped sod blocks that fit and butt perfectly.

Turf Doctor 23 cm **SG29200**
 Turf Doctor 15 cm **SG29202**



PATTISSON HEXAGON TURF DOCTOR



- Sturdy powder-coated hexagon plugger.
- Cuts 6 sided wedges of 18 cm (W) x 10 cm (D).
- Wedges easily stack in 'magazine'.

P605700



THE ORIGINAL HEX-PLUGGER - ONE-OF-A-KIND TURF REPAIR TOOL

- The patented Miltona original 12,7 cm Hex-Plugger has revolutionized turf repair.
- The hexagon shape causes the plugs in repaired area to interlock and remain in place on sloped areas.
- While additional sizes are now offered and the 17,8 cm has become our most popular model, Miltona has kept its commitment to quality by utilizing solid steel construction for the frames and cutting blades.
- All models include a trowel to maintain uniform plug depth.

Hex-plugger 17,8 cm model, cuts 5 cm deep plug **MT502107**
 Hex-plugger 17,8 cm model, cuts 7,6 cm deep plug **MT502108**
 Hex-plugger 12,7 cm model, cuts 5 cm deep plug **MT502105**
 Hex-plugger 12,7 x 20,3 cm model, cuts 7,6 cm deep plug **MT502110**



Repaired with the Hex-Plugger.



Repair attempted with hole cutter or round turf plugger.



Trowel included for uniform plug depth.

- REPAIR TOOL & SAFETY NET -



ADJUSTABLE DEPTH HEX-PLUGGERS

- These Hex-Pluggers can be adjusted to cut plugs from 5 cm to 12,7 cm in depth.
- Available in either a 17,8 cm or 22,9 cm diameter model.
- Both models come complete with hex cutting head and PowerStoke handle.

Adjustable Hex plugger, 17,8 cm **MT502117**
Adjustable Hex plugger, 22,9 cm **MT502119**

HEX-PLUGGER - CUTTING HEAD ONLY

Both sizes mount to Miltona or Par Aide Cup Cutter handles.

Adjustable Hex plugger, 17,8 cm head only **MT502127**
Adjustable Hex plugger, 22,9 cm head only **MT502129**

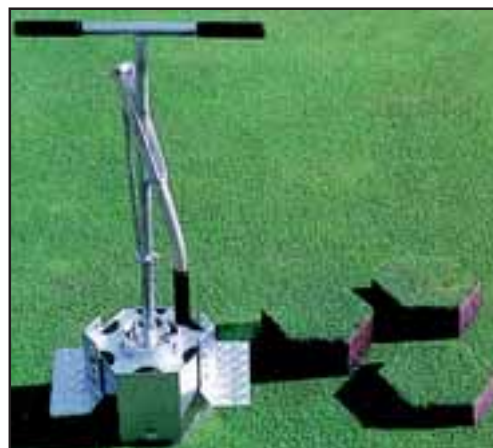

SAFETY NET

The 2 mtr x 1,8 mtr net provides ample protection for employees doing work in the line of fire. It's collapsable frame has aluminium uprights with fibreglass upper and lower cross pieces and heavy duty "step-in" stakes that secure the uprights. The net is high-strength polypropylene with high-visibility safety yellow borders.

Literally sets up in seconds.

- Weight: 9 kg.

Par Aide Safety Net **PA1100**



- REPAIR TOOLS & TURFJECTOR -



PLUG STACKER

- Choose a plug diameter to meet your needs.
- The Plug Stacker repair tools cut and stack 3,8 cm, 5 cm or 7,6 cm diameter plugs 5 cm in dept.
- Perfect for repairing small dead spots and ball marks.
- The storage tube holds up to 12 plugs.
- When an application calls for re-establishing a turf species from plugs, the Plug Stacker is a “must-have” tool.
- Its rugged, professional grade construction outperforms other plugs cutting devices.

Plug Stacker, 3,8 cm **MT500101**
 Plug Stacker, 5 cm **MT500102**
 Plug Stacker, 7,6 cm **MT500103**

Can also be used as a Ball Mark Plugger

Ball Mark Plugger 3,8 cm **MT500101**



MT500102



MT515503

GREENKEEPER EQUIPMENT

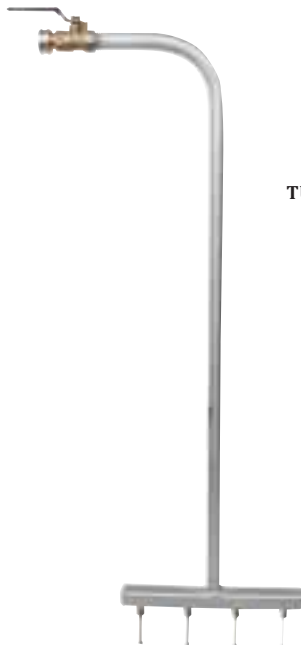

TURFJECTOR

- Your solution to dry spots.
- Wet down localized dry spots injecting water, wetting agents and other liquids.
- The Turfjector features 4 stainless steel injector tines that can penetrate the hardest turf up to 5 cm deep.
- It includes a ball valve to control water flow and connects to a 1,9 cm hose.

Turfjector **MT525570**
 Replacement Tine **MT525571**



- REPAIR TOOLS & SOIL TESTERS -



SOIL PROBE

- Use this soil sampling probe to remove cores for soil testing, checking your thatch layer or your turf's root growth.
- Takes up to a 38,1 cm sample and has a replaceable 1,9 cm cutting tip.

Soil Sampling Probe **MT520515**
 Extra Probe Tip **MT520516**



SOIL PROFILER

- Study your greens' soil profile.
- This profiler will give you a great soil sample 2,5 cm thick by 10,1 cm wide an up to 17,8 cm deep.

MT520520

SOD STRIPPER

- Miltona's Sod Stripper will come to the rescue after, a hydraulic leak or unfortunate vandalism. It is also perfect for use during irrigation upgrades.
- The 152,4 cm length helps the Sod Stripper easily cut out strips of the damaged area as well as matching replacement strips from your turf nursery.
- Depth of cut adjustable between 1,6 cm and 2,5 cm.
- Heavy duty steel construction with zinc plating ensure the durability of the tool.

Sod Stripper Combo with 5 cm, 7,6 cm, 12,7 cm and 17,8 cm blades
 Sod Stripper Super Combo with 4 blades plus 17,8 x 5 cm Deep Cut blade

MT510220
MT510221

Sod Stripper with 5 cm blade
 Sod Stripper with 7,6 cm blade
 Sod Stripper with 12,7 cm blade
 Sod Stripper with 17,8 cm blade
 Sod Stripper with 17,8 x 5 cm Deep Cut blade

COMPLETE
MT510212
MT510213
MT510215
MT510217
MT510218

BLADES ONLY
MT510222
MT510223
MT510225
MT510227
MT510228

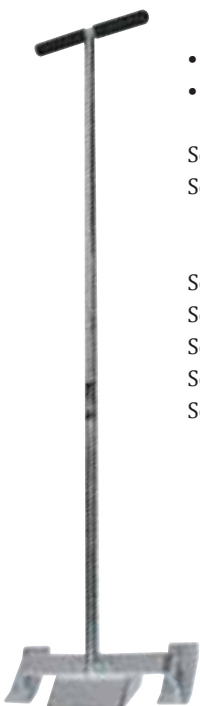

Hydraulic Oil Leak

20 minutes later



Deep cut blade

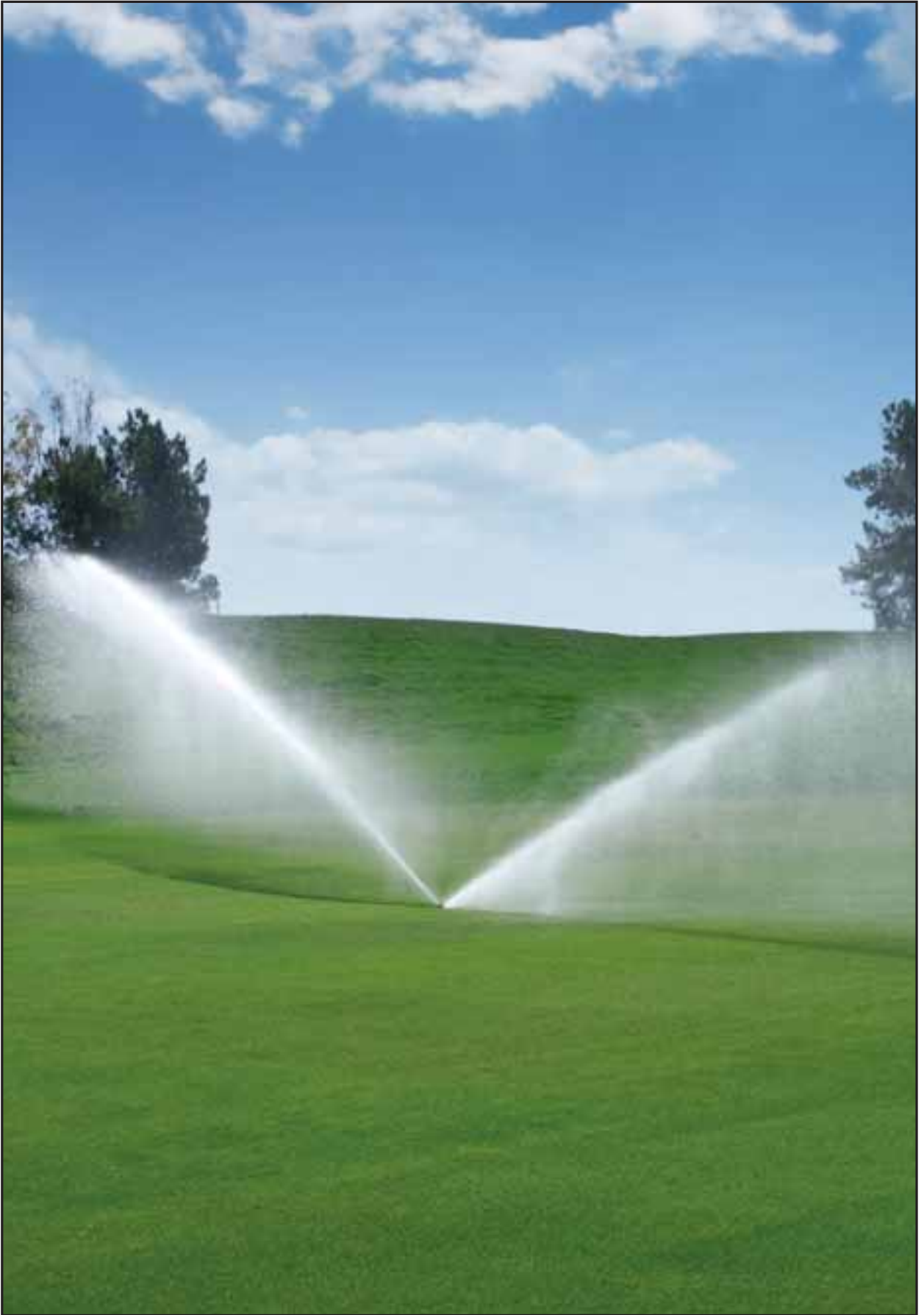

IRRIGATION ACCESSORIES

Hoses & Hose Cars	210 - 211
Hose Accessories	212
Nozzles	213 - 215
Applicators	215 - 216
Sprinkler Tools	217
Quick Coupling, Valves and keys	218
Portable Irrigation	219 - 220
Water Removal Pumps	221
Auditing Kits, Tufspy & Detection Glasses	222
Sprinkler Nozzles	223



- HOSES -



ULTRA MAX CLEAR HOSE

SMOOTH FINISH AND LIGHTWEIGHT

An economical multi-purpose clear hose made of clear Pliovic material and reinforced spiral yarn for extra strength.

Ideal for light to medium commercial duty including golf course greens.

- 600 PSI/ 41,36 bar burst pressure.
- Machined brass couplings.
- Non-conductive hose.
- Lightweight, durable.
- Thick outer wall.
- Very smooth finish.
- Available in lengths of 15,2 mtr, 22,8 mtr, 30,5 mtr and in thickness of 19 mm (¾") and 25 mm (1").

19 mm and 15,2 mtr ***UH10-050C***

19 mm and 22,8 mtr ***UH75-075C***

19 mm and 30,5 mtr ***UH75-100C***

25 mm and 22,8 mtr ***UH10-075C***

25 mm and 30,5 mtr ***UH10-100C***



ULTRA MAX BLUE HOSE

ULTRAMAX™ HOSE - FEATURING OUTSTANDING DURABILITY AND PERFORMANCE

Underhill Ultra Max hose employs the highest standard of precision engineering in design and manufacturing.

Don't settle for less. Ultra Max BlueAll weather performance in an ultra flexible lightweight hose.

Up to 45% lighter than comparable commercial quality hose.

Made of super, heavy-duty, longlife flexible TPE material.

Don't settle for less, choose the best!

- 1200 PSI/ 82,74 bar burst pressure.
- Machined brass couplings.
- Flexible, smooth finish.
- All weather performance.
- Abrasive resistant.
- Available in the length of 15,2 mtr, 22,8 mtr, 30,5 mtr and in the thickness of 19 mm (¾") and 25 mm (1").

19 mm and 22,8 mtr ***UH75-075B***

19 mm and 30,5 mtr ***UH75-100B***

25 mm and 15,2 mtr ***UH10-050B***

25 mm and 22,8 mtr ***UH10-075B***

25 mm and 30,5 mtr ***UH10-100B***

25 mm and 50 mtr ***UH10-150B***



- HOSES & HOSE CARS -

TRICOFLEX SOFT & FLEX TECHNOLOGY HOSE

The quality standard for professional water hoses with knitted reinforcements in 5 ply foam construction.

- High abrasion and UV resistant cover.
- High kink and torsion resistance.
- High flexibility.
- Excellent dimensional stability under pressure.
- Lead, cadmium and barium free.

Working Pressure 10 - 8 bar
Burst Pressure 25 - 20 bar

25 mm (1") cost per mtr **TRICO25**

25 mm (1") 25 mtr roll **TRICO25-25**

25 mm (1") 50 mtr roll **TRICO25-50**

25 mm (1") 100 mtr roll **TRICO25-100**



HOSE CAR HEAVY DUTY FOR 25 MM (1") HOSE

- For proper storage and safe transportation.
- Made of steel, plastic coated red/black.
- Connection with 25 mm (1") coupling.
- Max. capacity 100 mtr of 25 mm (1") hose.
- Nett weight approx. 24 kg.
- Weight with 100 mtr of 25 mm (1") hose: 69 kg.
- Dimensions: 75 x 75 x 80 cm.

UT-410



HOSE CAR PRO FOR 19 MM (3/4") HOSE

- For proper storage and safe transportation.
- Made of steel, coated orange.
- Connection for 19 mm (3/4") hose.
- Max. capacity 30 mtr of 19 mm (3/4") hose.
- Nett Weight approx.: 13 kg.
- Weight with 30 mtr of 19 mm (3/4") hose: 30 kg.
- Dimensions: 55 x 65 x 108 cm.

UT-420



- HOSE ACCESSORIES -

SOLID BRASS, ULTRA-RELIABLE

For reliable, crush proof, high-performance year after year, you just can't beat our machined brass hose repair fittings.

HOSE WASHER

19 mm ($\frac{3}{4}$ ")

UHN075W

25 mm (1")

UHN100WC



COUPLING BRASS MENDER

13 mm ($\frac{5}{8}$ ")

UHRBM-58-C

19 mm ($\frac{3}{4}$ ")

UHRBM-75-C

25 mm (1")

UHRBM-10-C



GEKA BRASS MENDER WITH QUICK CONNECTOR

19 mm ($\frac{3}{4}$ ")

UHQCBM-19-C

32 mm ($1\frac{1}{4}$ ")

UHQCBM-32-C

40 mm ($1\frac{1}{2}$ ")

UHQCBM-40-C



GEKA QUICK CONNECTORS

FEMALE

19 mm ($\frac{3}{4}$ ")

UHRBM-19-F

25 mm (1")

UHRBM-25-F

32 mm ($1\frac{1}{4}$ ")

UHRBM-32-F

40 mm ($1\frac{1}{2}$ ")

UHRBM-40-F

MALE

19 mm ($\frac{3}{4}$ ")

UHRBM-19-M

25 mm (1")

UHRBM-25-M

32 mm ($1\frac{1}{4}$ ")

UHRBM-32-M

40 mm ($1\frac{1}{2}$ ")

UHRBM-40-M



CLAMP FOR HOSE

Clamp for 13 - 19 mm

UHWC-050-125

Clamp for 19 - 25 mm

UHWC-075-175



HIGH-FLOW VALVES COMPOSITE / STAINLESS STEEL

19 mm ($\frac{3}{4}$ ") hose thread inlet/outlet, oversized handle, up to 208 L/min (55 GPM).

UA-BV77FM



HIGH-FLOW VALVES SOLID BRASS

19mm ($\frac{3}{4}$ ") hose thread inlet/outlet, up to 189 L/min (50 GPM).

UCV075H

- NOZZLES -



ULTRAMAX NOZZLE

PREMIUM HOSE-END NOZZLES & ACCESSORIES

Step up to the most professional nozzle you can buy - MAGNUM™ UltraMax. Firefighter quality for professionals in any field, these variable flow, multi-function nozzles are virtually indestructible and leak proof. The innovative TURBO SHIFT models provide two distinct GPM ranges. And the outstanding distribution patterns of all MAGNUM UltraMAX nozzles make them excel in high demand areas like greens/tees, infield conditioning and equipment and stadium washdowns.

- Multi-Pattern Spray: fog, jet stream, fan.
- Built for 25 mm (1") and 19 mm (¾") hose flow rates (range: 26 - 163 L/min or 7-43 GPM).
- Materials: aircraft aluminum, stainless steel, TPR rubber.
- Nozzles and valves rated at 600 PSI working pressure.
- Available in 2 different versions.



Full Throttle



ULTRAMAX FULL THROTTLE

- Single variable flow: delivers steady, maximum volume fog, jet stream and fan patterns. High flow model: 15-40 GPM (57-151 L/min).

UNG500-SFH-75

ULTRAMAX TURBO SHIFT

- Dual variable flow: delivers light fog and low volume jet stream patterns before shifting to high volume jet stream and fan patterns. High flow model: opens with 12-17 GPM (45-64 L/min) turbo shifts to 20-43 GPM (76-163 L/min).



Turbo Shift

UNG550-DFH-75

MAGNUM HOSE NOZZLE

SOLID METAL HOSE NOZZLE

Underhill® Magnum™ contains no plastic internal parts to break, stick or wear out. Our unique ratchet mechanism easily adjusts from gentle fan to powerful jet stream and prevents over-tightening damage. Precision-machined, incredibly smooth operation and outstanding distribution patterns make it ideal for high-demand areas like greens and tees. Magnum™ is also an excellent equipment wash-down nozzle.

- Solid metal internal - no plastic parts to break or wear out.
- Multi-pattern sprays - effortless control with hydraulic assist on/off.
- Ratchet mechanism prevents over-tightening damage.
- Fire hose quality nozzle feels great in your hands.
- Built for 25 mm (1") and 19 mm (¾") flow rate.
- Materials: stainless steel, aluminum, TPR rubber.
- Flow: 140 L/min at 5,5 bar (37 GPM at 80 PSI).



UNG450

- NOZZLES -



SWEEPER NOZZLE

PowerBlast™ SOLID BRASS NOZZLE SERIES

Heavy duty solid machined brass construction nozzles built to perform and last. Low flow designed to save water yet produce high power jet output. Ideal for equipment power wash down, cleaning driveways and walkways with minimum water usage -26 L/min at 5,5 bar (7 GPM at 80 PSI).

- Available in 2 sizes both for the 19 mm (¾"): 5 cm (2") and 15 cm (6").

5 cm **USN2-75**
15 cm **USN6-75**



MULTIMAX ADJUSTABLE NOZZLE

MULTIMAX ADJUSTABLE NOZZLE 10 cm (4")

High Pressure Easy Twist variable pattern nozzle, no leak design fine mist to power jet spray adjustment 19 L/min at 5,5 bar (5 GPM at 80 PSI).

- Solid machined brass construction.
- Constant flow smooth operation.
- Simple reliable long life.

UGNA-75



COOLPRO NOZZLE

COOL WITHOUT OVER WATERING - NO ROOT DAMAGE

A hot summer day can be murder on your greens. Use too much water and you risk damage to the roots. CoolPro™ is the first nozzle specifically designed for the single purpose of lightly misting the turf canopy to cool without over watering. And its 25 foot fogging pattern gets the job done quickly.

- Perfect for tournament play, CoolPro™ puts down only enough water to cool the turf canopy. It prevents wilting while maintaining good ball speed.
- Precision™ nozzle fogs at 4,82 bar/ 70 PSI to deliver a 7,62 mtr/ 25 ft. pattern with only 15-22 L/min (4-6 GPM).
- 19 mm (¾") inlet (25 mm (1") brass adapter available.
- Ergonomic handle/valve provides easy grip and variable on/off control.
- Durable solid metal design.

UHNC075



- NOZZLES & APPLICATORS -



PRECISION NOZZLE

SOLID METAL, SPECIFIC TASK HOSE NOZZLES

Underhill® Precision™ nozzles deliver millions of soft, uniform droplets to provide rapid yet surprisingly gentle water application over a huge range of flow rates. From soft watering to powerful drenching, patented Precision nozzles are designed with ideal flow rates and droplet sizes to fully irrigate without disturbing turf, dirt, seeds, etc., providing a precise solution for every hand watering application.



Rainbow™ TASKS: Greens, tees, seed beds, transplants, delicate landscaping 57 ltr / min (15 GPM).

UHN1500-YELLOW



Cloudburst™ TASKS: Dry spots, drenching, and wetting agent application >132 ltr / min (35+ GPM)

UHN4800-BLUE



Cyclone™ TASKS: Pre-game skins watering, heavy watering of large areas, ideal for hydroseeding >189 L/ min (50+ GPM)

UHN5000-RED

Note: L/min (GPM) will vary with pressure at nozzle



LIQUIDPRO APPLICATOR

APPLICATOR GUN FOR LIQUID WETTING AGENT

The LiquidPro is chemical-resistant, UV-protected, lightweight siphon mixing system can cover 1000 square feet in less than a minute! With unmatched speed and uniformity, you can virtually “paint” your turf with liquid wetting agent, fertilizers, and micronutrients. Adjustable metering dial offers 10 additive settings including “Water Only.”

LiquidPro Gun, with 25 mm (1”) FHT x 19 mm (¾”) MHT adaptor
 LiquidPro Gun, with 19 mm (¾”) Quick connect adaptor
 6 pack of 32 oz. Polybottles and Carrier



UA-LPWA50K
UA-LPWA50K-E
UA-LPWAB-6

PELLETPRO APPLICATOR

APPLICATOR GUN FOR SOLID WETTING AGENT TABLETS

Our heavy-duty surfactant applicator, high-flow valve and Precision™ Cloudburst™ nozzle combo comprises the finest wetting agent gun available. PelletPro™ accepts all wetting agent tablets and provides a high volume, yet soft spray for watering or applying surfactants to tight, hydrophobic soils.”

- 35+ GPM to get the job done faster!
- Ultra Heavy-Duty construction: brass fittings, aircraft aluminium, stainless steel, precision engineered glass.
- Pellet rotation (1 RPS) evenly dissolves/applies tablets.

In-line Applicator Option

Connect directly to a water source (quick coupler, HoseTap, etc.) to get the benefits of PelletPro with less handheld weight.

PelletPro Gun, with 19 mm FHT inlet - MHT Outlet
 PelletPro Wetting Agent Applicator Gun



PelletPro's bowl works great as an in-line filter replacement for most spray rigs. Heavy-duty, transparent bowl shows fluid levels, won't crack during winter storage.

UA-PPQ-075
UA-PPWA50K-E

- NOZZLES & APPLICATORS -



FLO-PRO INLINE APPLICATOR

In-line applicator for liquid wetting agent

The lightweight portable solution to apply surfactant to tight hydrophobic soils. Also, ideal for liquid or soluble fertilizers and soil amendments. Easy connection to water source (quick coupler, HoseTap, etc). Just attach your favorite nozzle like the Precision Cloudburst or RainPro and your ready to go.

- Larger 3,79 litre (1 gallon) tank.
- Made of high impact PVC.
- Adjustable feed rate.
- Can also apply fertilizers and soil amendments.
- Inline applicator includes coupling and on/off ball valves



Flo pro inline **UIHB-1010**



DRAINBLASTER CLEANING NOZZLES

HIGH PRESSURE DRAIN CLEANING NOZZLE

This unique hose-end, high pressure nozzle guides itself in cleaning out drains, to remove debris with ease. Special feature includes a wire attachment connector for using wire locator to determine drain route.

- Front jet cuts through blockage.
- Rear jets propel nozzle upline.
- Two stage flushing action.
- Minimum water pressure: 4,82 bar (70 PSI).
- Heat treated grade 303 stainless steel for long life.
- Available in 2 sizes: 19 mm (¾") and 25 mm (1").



Great for cleaning under sidewalks of cart paths.



Ideal for 10-15 cm (4-6") drains and catch basins

19 mm **UDN-75**

25 mm **UDN-10**

RAINPRO SHOWER NOZZLES

SOLID METAL SHOWER NOZZLE

A truly revolutionary shower nozzle for soaking turf or other landscapes featuring an exclusive solid brass nozzle plate for outstanding pattern and special rubber bumper for nozzle protection.

- Ultra durable construction withstands any abuse.
- Beautiful, consistent and uniform spray pattern.
- Materials: zinc alloy, brass and TPR rubber.
- Flow: 151 L/min (40 GPM) @ 5,5 bar (80 PSI) built for 25 mm (1") and 19 mm (¾") hose flow rates.
- Nozzle assembly unscrews for easy cleaning.
- Excellent for golf greens or other turf and landscape applications.



19 mm **USHN-75**

25 mm **USHN-10**

- SPRINKLER TOOLS -



SUPERKEY XL

MULTI-PURPOSE TOOL FOR TORO, RAINBIRD GOLF SPRINKLERS

The ultimate all-in-one tool for your golf sprinklers, think of it as a Swiss army knife, a must have companion. Made of stainless steel and composite material, it effortlessly turns electric valve-in-heads on and off, removes internal snap rings and performs many other sprinkler maintenance chores. Great for John Deere/Signature® sprinklers, too!



UA-SKTRB



EASYREACH KEY

EXTRA-LONG SHAFT ON/OFF KEY

Extra long and extra heavy duty metal key designed for easy on/off operation for Toro, Rain Bird and John Deere/Signature electric valve-in-head golf sprinklers. Made of high grade metal, EasyReach offers years of effortless on / off operation.



For Rain Bird

For Toro and John Deere

For Rain Bird

UA-ERR

For Toro and John Deere

UA-ERT

VERSALID

VALVE BOX UNIVERSAL REPLACEMENT LID

VersaLid™ is the easy solution for broken or missing valve box lids. No need to guess what brand a buried box is or even worse - dig it up to find out - VersaLid's locking system fits all 15,24 - 17,78 cm (6" - 7") round valve boxes.

- Fits all 15,24 - 17,78 cm (6" - 7") round boxes.
- Universal fit.
- Greater top-load strength and more UV-resistant than structural foam lids.



UVL-6

SPLICE KIT

3M DIRECT BURY SPLICE KIT

Each kit includes one wire connector which accommodates wire sizes from 1, 219 - 3,251 mm (18 - 10 gauge) and a waterproof gel case. Excellent for golf, commercial and residential applications.



UDBRY

- QUICK COUPLING, VALVES & KEYS -



SOLID BRASS, SINGLE SLOT/LUG ESSENTIALS

Built to last, Underhill valves and keys are constructed of solid red brass and stainless steel. Valves incorporate rugged one-piece design.



Valve



Quick Coupling Key



Hose Swivel

VALVES

- 19 mm (3/4") FPT inlet **UQV-075R**
- 25 mm (1") FPT inlet **UQV-100R**
- 38 mm (1 1/4") FPT inlet **UQV-150R**

QUICK COUPLING KEYS

- 19 mm (3/4") MPT - 13 mm (1/2") FPT outlet **UQK-075**
- 25 mm (1") MPT - 19 mm (3/4") FPT outlet **UQK-100**
- 38 mm (1 1/2") MPT - 32 mm (1 1/4") FPT outlet **UQK-150**

HOSE SWIVELS

- 19 mm (3/4") FPT - 19 (3/4") mm MHT outlet **UHS-075**
- 25 mm (1") FPT - 19 mm (3/4") MHT outlet **UHS-100**
- 25 mm (1") FPT - 25 mm (1") MHT outlet **UHS-101**
- 38 mm (1 1/2") FPT - 32 mm (1 1/4") MHT outlet **UHS-151**

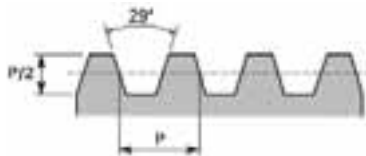

ACME THREAD

The tooth shape has a wider base which means it is stronger (thus, the screw can carry a greater load) than a similarly sized square thread. They are typically found where large loads are required. This is due to the need to avoid "wedging" of the thread flanks when subjected to large loads and gradually increasing loads.

- Quick Coupler 25 mm (1") ACME thread **UQB44RCAT10**
- Quick Coupler key 25 mm (1") ACME thread **UQB44KAT10**



For Toro



For Rain Bird & Eagle

HOSE TAP

SOLID METAL HOSE ADAPTER

HoseTap™ gives you a hose connection anywhere you have a Toro® or Rain Bird® electric, valve-in-head sprinkler. A fast connection when quick-couplers or hose bibs are not available. Includes aircraft aluminum body (won't break or wear out like plastic) anodized with sprinkler manufacturer color, o-ring, riser, 1" brass swivel and 3/4" adapter. Also available without brass swivel/adapter. Tap includes a brass swivel and adapter

- Tap for Toro 25 mm (1") inlet Sprinkler **UHN-T100B**
- Tap for Toro 38 mm (1 1/2") inlet Sprinkler **UHN-T150B**
- Tap for Rain Bird & Eagle 700 Sprinkler **UHN-R125B**
- Tap for Rain Bird & Eagle 900 Sprinkler **UHN-R150B**

- PORTABLE IRRIGATION -



IMPACT SPRINKLERS

SOLID BRASS, ULTRA-RELIABLE WORKHORSES

For reliable, trouble-free, high-performance year after year, you just can't beat our brass impact sprinklers. Available in full circle in inlet sizes of 19 mm (¾"), 25 mm (1"), and 32 mm (1¼").

- Solid brass construction.
- Stainless steel drive spring.
- Bearing assembly hood for longer wear life.
- Chemical resistant bearing seals.
- Solid brass nozzle.

19 mm (¾") MPT **USI075F**
 25 mm (1") MPT **USI100F**
 32 mm (1¼") MPT **USI125F**



ROLLER PRO PORTABLE SPRINKLER BASE

The 56 cm (22") wide stainless steel roller of RollerPro™ provides a stable field position for supplemental watering. Designed for years of hard use, it is ideal for watering dry spots and newly seeded areas.

- 56 cm wide stainless steel roller is weighted to prevent movement during use.
- 19 mm (¾") inlet and outlet adapters included.
- Standard 25 mm (1") FHT inlet x 25 mm (1") female NPT outlet.

Roller Pro **UA-RP221**



DEEP DRIP

TREE WATERING STAKES

Water and fertilize your trees at the roots, encouraging deeper roots and healthier trees with DeepDrip™ stakes. Water gets underground fast, so you can irrigate for shorter periods and save water. They also help aerate the soil, and you can add fertilizer into the shaft to direct nutrients to the root zone.

Three Lengths For All Tree Sizes: Use the 37 cm stake for shallow root trees and shrubs, like rose bushes and ornamental trees (or boxed trees). The 62 cm stake is best for most other tree varieties except for palms and similarly deeper rooted trees, which will benefit from the longer 91 cm stakes.

Built Smart - And Easy To Use: The DeepDrip's reinforced tip and cap are made from ABS and the upper shaft is made from Schedule 40 PVC. Multiple holes in the bottom half of the spike, internally covered by a mesh filter, allow water to flow out but keep dirt from getting in and clogging the tube. The UV-protected cap acts as a reinforced cover when pounding the stake into the ground, keeps debris from entering the shaft and holds a 6,4mm (¼ inch) drip line/emitter securely in place. By inserting a screwdriver through the two holes at the top of the upper shaft, stakes can be easily pulled up to remove/reposition, or rotated to deter root invasion.

Deep drip 37 cm **UA-DD14**
 Deep drip 62 cm **UA-DD24**
 Deep drip 91 cm **UA-DD36**



ADD TO EXISTING TREES! Install DeepDrip™ stakes during or after tree planting for instant access to the root system for fertilizer delivery or to set up deep automatic drip watering.

- PORTABLE IRRIGATION -

TRACKER

The Tracker™ offers an economical solution for supplementing seasonal watering needs of 1000 m² to 8000 m² areas. It's also ideal for irrigating athletic fields, cemeteries, golf course roughs, or other large areas where an underground system is impractical. Built to last with precision German engineering and high quality materials, this portable powerhouse can irrigate an entire football field in just two passes.

Tracker™ requires minimal labor to operate. Powered by water, it pulls itself along a nylon cable, dragging up to 110 mtr of 25 mm (1") reinforced heavy-duty hose (sold separately). Each pass irrigates about 2500 m² per 8 hours of operations.

- Adjustable Speed Control: 6 - 20 mtr / hr.
- Standard full or part circle sprinkler 30,28 - 56,78 ltr / min (8-15 GPM).
- 110 mtr nylon cable provides irrigated length of 122 mtr.
- 21 - 26 mtr pass width.
- Automatic shut-off at end of pass.
- Water turbine drive and gear box.
- Galvanized anchor stake.
- Includes 25 mm (1") brass quick-connect adapter.

SPECIFICATIONS:

- Weight: 26,31 kg.
- Size: Length: 84 cm, Width: 56 cm, Height: 56 cm.
- Materials: Aluminum, Brass, ABS.
- Minimum Water Pressure: 3,45 bar (50 PSI).
- Hose Required: 25 mm (1").

UT-400



Precision German engineering, high quality components built to last!



- WATER REMOVAL PUMPS -



GULP ULTRAMAX PLUS

SUPER HIGH-CAPACITY WATER REMOVAL SUCTION PUMPS

Whether you need to remove water from sprinklers and valve boxes or other areas or devices, UltraMax series pumps are the ideal tools for the job.

- Highest quality materials and attention to details.
- Unique replacement plunger seal and O-Ring wiper.
- Seal assemblies for extra long pump life.
- Self priming, high volume water capacity.
- Super-grip ergonomic pump handle.
- Super smooth & durable pumping action.
- Replacement part kits available.

BIG GULP ULTRAMAX PLUS

- 992 gr/stroke.
- 91 cm pump chamber.
- 91 cm or 180 cm outlet hose.

91 cm Outlet Pump **UA-G3636-CK**
 180 cm Outlet Pump **UA-G3672-CK**



GULP ULTRAMAX PLUS

- 510 gr/stroke.
- 35, 56 cm pump chamber.
- 45 cm outlet hose.

45 cm outlet pump **UA-G12-C**



GULP SYRINGE ULTRA

- 340 gr/stroke.
- 30,48 cm pump chamber.
- 30 cm outlet hose.

30 cm outlet pump **UA-G12S-C**



-AUDITING KITS, TURFSPY & DETECTION GLASSES-



CATCHCAN PRO

EXPERT SPRINKLER PERFORMANCE

Increasing watering times to compensate for poorly performing sprinklers wastes a lot of water. Accurately measuring sprinkler application rates with Underhill® AuditMaster™ helps maximize water savings.

- Self standing - easily anchors into turf, even on slopes.
- Measures sprinkler application in inches or centimeters.
- Unique design allows for shorter duration test.
- Made of durable polypropylene engineered plastic.
- Can be stacked for easy storage.
- Each 12 pack kit comes with instructions.

UCCPK-12

TURFSPY GLASSES

EARLY STRESS DETECTION GLASSES

Disease, drought and weed invasion are plant and turf killers. But by the time you see them it can be too late. TurfSpy™ glasses, with stress detection technology developed by NASA, lets you “see into the future” to identify problems 2-10 days before they are visible to your naked eye. Keep your turf and vegetation healthy BEFORE serious problems arise.

HOW IT WORKS

Dying vegetation absorbs and reflects sunlight differently than when its healthy. The earliest signals occur at the outer limits of the human visual spectrum, and are rendered invisible compared to the predominant middle wavelengths. TurfSpy™ filters the light in the center so that fringe spectra, which show early plant stress, become visible.



Fusarium patch



Brown patch



Superior weed location and spraying saves time and money.



Get a jump on broken or poor-performing sprinklers.

- Shatterproof / polycarbonate stress detection lens (ANSI-approved safety lens).
- Wrap-around lens limits ambient light for optimal detection.
- Sports frame with adjustable ear piece.
- Lightweight case included.

UNG655-01



HEADCHECKER

NOZZLE DISCHARGE PRESSURE GAUGE

Use this liquid-filled 11 bar (160 PSI) gauge with 76 cm (30”) flex hose and solid brass Pitot tube, hose bib, or spray head adapter to measure water pressure at discharge points.

UA-PHG-160K

- SPRINKLER NOZZLES -



PROFILE SOLID METAL GOLF SPRINKLER NOZZLES

Upgrade your sprinklers with Profile™, the ultra-high uniformity, water conserving, solid metal nozzles from Underhill. You will see improved results immediately, save millions of gallons of water every year and improve the playability of your course at the same time guaranteed.

Profile nozzles are so consistent, with distribution patterns so uniform it's like rain on demand.

51 SERIES BRASS IMPACTS - RAINBIRD



Full circle: front / rear nozzles.

Nozzle colour # range / spreader

White 14 / Gray 11.5	UR51-1411.5
Blue 16 / Gray 11.5	UR51-1611.5
Yellow 18 / Gray 11.5	UR51-1811.5
Red 20 / Gray 11.5	UR51-2011.5
Green 22 / Black 13	UR51-2213
Black 24 / Black 132	UR51-2413



630 SERIES - TORO

On request



670 SERIES - TORO

Full circle: rear nozzles.

Nozzle colour: midrange / close-in

Black / Yellow **UT670-BY**



730 SERIES - TORO

Full circle: front / rear nozzle set

Nozzle colour # range / spreader

Brown 33 / Grey 13	UT730-3313
Blue 34 / Grey 13	UT730-3413
Violet 35 / Red 15	UT730-3515
Green 35 / Red 15, (50 PSI)	UT730-3515L
Red 36 / Red 15	UT730-3615
Red 36 / Lavender	UT730-3617

750 SERIES - TORO

Full circle: front / rear nozzle set

Nozzle colour #range / spreader

Red 56 / Lavender 17	UT750-5617
Gray 57 / Lavender 17	UT750-5717





PRO SHOP SUPPLIES

- PRO SHOP -

Together with our partner Piguy Golf Challenge, Duchell can offer an extensive range of Pro Shop supplies.

Do ask us which brands we have available for your specific country.

Some of the brands Piguy Golf Challenge represents in France:

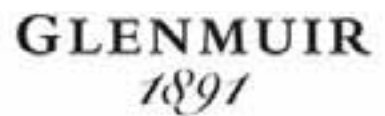

WELLSTROKE MAT

PRO

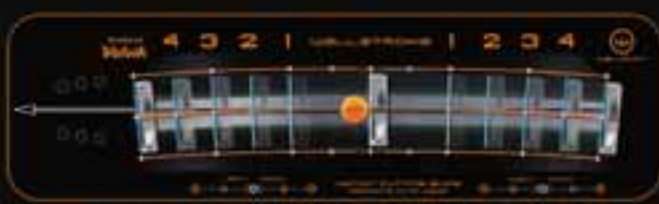

Using instructions
see the app
to control the
mat's intensity
control
control
control
control
control
control

WELLSTROKE designed by Olivier Légas, printed on the mat

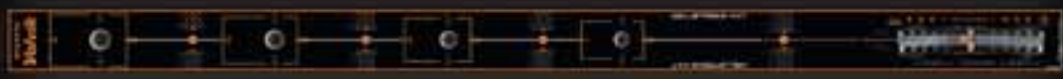

1 WELLSTROKE MAT

5.50m x 0.35m / 18ft x 1ft

- WELLSTROKE MAT
- WELLSTROKE
- WELLBALLS
- WELLTEES



Volvik



WELLPUTT

PIGUY
GOLF
CHALLENGE

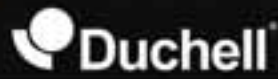

- PRO SHOP -



Offering the world's largest range of user-friendly motorised buggies



PIGUY
GOLF
CHALLENGE

 **Duchell**[®]

MGI has for decades, raised the standard of high performance buggies, offering the latest in design and innovative features

- PRO SHOP -

DUCHELL CAN PROVIDE THE FULL RANGE OF TEES AND CLEATS AND CAN ADVISE ON PRESENTATION IN PRO SHOPS.



PRO SHOP



- PRO SHOP -



GREENFEE GIFTS

Duchell offers a generic range of hospitality gifts as a standard stock product.

Standard items packed as stated below, sold in standard packs only.

Wooden Tees White (box of 5.000)	DU63441
Plastic Pitchrepairer White (box of 2.500)	DU63442
Plastic Ballmarker White (box of 10.000)	DU63443



THE GREENFEE GIFTBAG

Polybag consisting of:

- 1 plastic pitch repairer
- 1 plastic ball marker
- 5 wooden Tees (5,4 cm)
- 1 pencil with eraser
- Minimum order quantity: 10.000 bags.

INCLUDING:

- Print on tees & pencil: 1 colour.
- Print on pitch repairer & ball marker: up to 4 colours
- Print on polybag: up to 4 colours (only for orders of 10.000 pieces+)
- For 7 cm tees add € 0,01 per tee. **GIFTBAG01**



FORKY

Sexy plastic pitch repairer with the classy look of the dome insert for maximum attention for the logo. Thumb print in the pitch repairer for comfortable use.

Forky white	DU63450
Forky black	DU63451
Forky blue	DU63452
Forky red	DU63453
Forky pink	DU63454



Individual packaging

- Full colour dome print included on pitchfork.
- No setup charges.
- Packed in Bulk (100 pieces each pack).
- Individual packaging on request.

- GOLFVISION INCENTIVES -

DUCHELL HAS A FULL LINE OF GOLFVISION INCENTIVE PRODUCTS AVAILABLE.

PLEASE CHECK OUR WEBSITE AND ASK US FOR A SPECIFIC QUOTE.



Pitch Fork Eclipse **DU63010**



Pitch Fork Legacy **DU63020**



Ball Marks **DU63284**



Cap Clip **DU63290**



Key Chain Pendulum **DU63273**



Key Chain Valet **DU63274**



Letter opener **DU63278**



Ruler **DU63292**

- GOLFVISION INCENTIVES -



Memo holder **DU63080**



Tape Measure **DU63283**



Card case **DU63050**



Memo pad holder **DU63060**

E-key holder **DU63294**



Card Holder **DU63275**



Bottle tool **DU63270**



Bottle Stop **DU63271**



- TERMS AND CONDITIONS -

PRICING

All prices are in Euros and unless stated otherwise, per piece and are excluding VAT.

Prices are valid until December 31st 2020, however prices are subject to change at any time without prior notice.

Terms and conditions of sale are subject to change at Duchell BV's discretion without prior notice.

RETURN POLICY

If you are not entirely satisfied with your purchase.

RETURNS

You have 30 calendar days to return an item from the date of purchase. To be eligible for a return, your item must be unused and in the same condition that you received it. Your item must be in the original packaging. A copy of invoice or the packing slip describing what is returned and why must be provided. Damaged or obsolete items will not be credited. All products to be returned must have an official confirmation from Duchell stating that the return items will be accepted.

Distributors are not authorized to agree to returns on behalf of Duchell. Custom products, special items or non-stock items will not be accepted. All returns are subject to a 15% restocking charge.

Refunds

Once we receive your item, we will inspect it and notify you that we have received your returned item. We will notify you on the status of your refund after inspecting the item. If your return is approved, we will issue a credit.

Shipping

You will be responsible for paying for your own shipping costs for returning your item. Shipping costs are non-refundable.

If you receive a refund, the cost of return shipping will be deducted from your refund.

DELIVERY TERMS

Standard delivery is Ex Works Soesterberg, The Netherlands.

In some circumstances Duchell BV may organise transport on behalf of the customer with a local transport company.

In this case the transport costs will be invoiced to the customer. We cannot take any responsibility for lost or damage to goods during shipping.

FREIGHT DAMAGE

Any discrepancy or damage must be noted on the bill of lading at time of delivery. Contact the carrier to file a claim and also notify Duchell. Please note that if the bill of lading has been signed then the customer accepts the delivery and therefore has approved the goods.

WARRANTY

Items in the Duchell catalogue carry a 12 month warranty on fabrication faults.

Distributors are not authorized to give additional warranty / guarantees without prior approval from Duchell BV.

CREDIT TERMS

For customers with established commercial credit, full payment of all invoices is expected on the due date. A service charge of 1.5 % per month is imposed on all overdue balances. All products are property of Duchell BV until payment is received in full.

- PRODUCT INDEX -

1-piece balls	6	Ball Washer Attachment Teak	106	Cast Aluminium Head	145
2 Wheel Rental Trolley	114	Ball Washer Bracket	81	Cast Mow Over Sign 7	3
2-piece balls	6, 7	Ball Washer Consoles	83	Cast Tee Marker	88
3 Wheel Rental Trolley	114	Ball Washer Detergent Tablets	81	Catchcan Pro	222
360 degree Hole Paint	188	Ball Washer Ensembles	78, 79	Chain	99
360° Hole Painter	188	Ball Washer Parts	80, 84	Chain Stake	102, 103
3-gang Ball Picker	46, 47	Ball Washer Replacement Kit	86	Champ	228
3M Splice Kit	217	Ball Washer Twister	54	Checkered Flags	119
4-Combo Litter Bin	111	Ball Washers	52 - 54, 76 -84	Checkered Junior Flags	145, 148
		Ball Wings	14	Chix Tee Towels	113
		Balls	6, 7	Clamp for Hose	212
A		Banner Frames Aluminium	39	Classic Airlastic Range Mat	13
Accufix	197	Banners	39	Classic Ball Washer	83
Accuform Accufix	197	Barrier Hoops	99	Classic Imax Mats	13
Accuform Accuseed	203	Base	144	Classic Mat	13
Accuform Bunker Rakes	164	Basket Stand	25	Cleaning Nozzles	216
Accuform Landscape Rake	199	Baskets	24 - 25	Clear Hose	210
Accuform Plug Pusher	198	Bay Dividers	28, 30, 31	Clikka Bag	51
Accuform Screening Rake	199	Bearer for Rake	160	Clikka Tube	51
Accuseed	203	Benches	150, 151	Clikka Tube Steel	51
Accusmooth Maint. Bunker Rake	199	Big Cups	140	Clock kit	153
Acme Thread	218	Big Gulp	221	Clocks	153, 154
Acorn Nuts	121,126	Big Hole Cutter	202	Club Washer Parts	85, 86
Adaptor for Hose	218	Bins	106-111	Club Washers	85
Adjustable Bulls eye Target	36	Blades for Hole Cutters	178 - 183	Coco Fiber Drag Mat	192
Adjustable Depth Pluggers	205	Blowers	55	Coin Mechanisms	60
Adjustable Nozzle	214	Blowfill Manifold	55	Coins	60
Adjustable Tees	23	Blue Hose	210	Collectors	50, 51
Adjustable XL Tees	23	Board for Hole Cutter	187	Combo Litter Bin	111
Aeration Tools	200	Books	68	Combo Rope and Chain Stake	102
Air flex Mats	9	Boot Wipers	170	Comfort Bench	150
Airlastic Frames	12	Border Shears	176	Competition Markers	92, 93
Aluminium Banner Frames	39	Border Spade	176	Composite Handle	161
Aluminium Broken Tee Caddy	90	Bottle Stop	231	Cone Top Ball Dispensers	58
Aluminium Cup	135 - 139	Bottle tool	231	Consoles	83
Aluminium Cup With Sleeves	135,136	Bracket Club Washer	86	Containers	107 - 109
Aluminium Distance Markers	94	Braided Polypropylene Rope	99	Contest Indicators	92, 93
Aluminium Hole Cup	135 - 139	Brands	225	Cooler Pro	152
Aluminium Markers	96	Brass Mender	212	Coolpro Nozzle	214
Aluminium Mow Over Sign	73	Broken Tee Box	90	Copper Mow Over Sign	73
Aluminium Practice Green Cup	135 - 139	Broken Tee Caddies	90, 91	Copper Tee Marker	88
Aluminium Tee Marker	88	Broken Tee Caddy Covers	91	Core Buster Dragmat	192
Aluminum Handle	161	Bronze Mow Over Sign	73	Core Cleaning	195
Applicator for Paint	177	Bronze Tee Marker	88	Core Hog	195
Applicators	215, 216	Brush Stand	171	Cotton Tee Towels	113
Arrows	72	Brushmaster Electric Shoe Cleaner	173	Coupling Brass Mender	212
Artificial Turf	20, 21	BT1000 Washer	53	Course Info Signs	72 - 75
Atomic Clock	154	BT1300 Washer	52	Course Map	72 - 75
Auditing Kits	222	BT1950 Washer	52	Cover Broken Tee Caddies	91
Augusta Tee Markers	87	Bubble Level	179, 180	Covers for Cups	141
		Bulls Eye Target	36	Credit Card System	61, 63
B		Bulls Eye Target Pro XL	36	Crew Caddy	186
Backless Benches	150	Bunker Debris Rake	169	Cross Tees	23
Bag & Caddy Lockers	64 - 66	Bunker Rake	160-169,199	Cup Auger	184
Bag Stand with cup Holder	26	Bunker Rake Handle Decals	160	Cup Covers	141
Bag Stands	26	Bunker Rake Handles	160-169	Cup Dispenser	112
Ball Collectors	46-51	Bunker Stamp	169	Cup Hook	185
Ball Dispensers	57 - 59			Cup Plugs	141, 195
Ball Mark Eraser	203	C		Cup Puller	185
Ball Mark Repair Tool	197	Cable Laying Shovel	176	Cup Ring	189
Ball Marker	229, 230	Caddy Books	68	Cup Saver	185
Ball marks	230	Caddy Lockers	64 - 66	Cup Setters	184
Ball Picker Spare Parts	49	Cage	43	Cups	135 - 139
Ball Pickers	46, 49	Cap Clip	230	Cups Accessories	141
Ball Pickers	46 -49	Card Case	231	Cups for Water Cooler	112
Ball Scoop	50	Card holder	231	Custom Bay Divider	28
Ball Stackers	25	Cards	69	Custom Decals for Ever White Sleeve	136
Ball Storage Box	152	Cards Systems	61, 63	Custom Shape Mats	10
Ball Transportation Systems	55, 56	Cashless Terminal	61, 63	Custom Sleeves	135
Ball Trays	14	Cast Alu Practice Green Markers	144, 145	Cutter Carrier	186
Ball Washer Accessories	80, 81				

- PRODUCT INDEX -

D		Explanar	34	H	
Debit Card System	61, 63	Extension for Ball Pickers	46, 47	H&D Golf Lockers	64 - 66
Debris Rakes	169	Extra Large Practice Green Marker	147	Hand Aerifier	200
Decal Sets for Dimple T-Markers	88	E-Z Whip Whipping Pole	190	Handles for Rake	160-169
Deep Drip Watering Stakes	219			Hardwood Maintenance	70
Deluxe Ball Washers	76	F		Hazard Markers	100, 101
Deluxe Ensembles	79	Fairway Distance Markers	96	Hazard Markers End Caps	101
Deluxe Scrusher	171	Fairway Marking Pole	96	Head Trimmers	200, 201
Deluxe Steel Rope Stake	102	Fairway Signs	155 - 159	HeadChecker	222
Depth Gauge	187	Ferrules	123, 125, 129	Heads for Rakes	160-169
Detection Glasses	222	Fiberbuilt 4-panel Insert	17	Heavy Duty Ball Picker	48
Detergent	81	Fiberbuilt Mats	16, 17	Heavy Duty Hole Cutter	183
Dew Tools	190 - 193	Fiberbuilt Rubber Frames	16	Heavy Duty Hose Car	211
Dewmaster	191	Fiberbuilt Rubber Wing	17	Heavy Nylon Net	42
Dimple T-Markers	88	Fiberglass Hollow Handle	166	Hexagon Turf Doctor	204
Direction Arrows	158	Fiberglass Honeycomb Handle	166	Hex-plugger	204
Direction Signs	155 - 159	Fiberglass Rod	144	Hex-pluggers	204
Directional Markers	100	Finger Posts	72	High Flow Valves	212, 218
Discs Pickers	49	Flagpoles	122 - 130	HIO Bubble Level	180
Dispensers for Balls	57 - 59	Flags	37, 115-121, 148, 149	HIO Hole Cutter	180
Distance Markers	94 - 98	Flags with Logo	120, 121, 148, 149	HIO Hole Cutter Parts	181
Distance Measurement	131	Flags, Junior	145, 148, 149	Hitting Cage	43
Distance Plates	97, 98	Flagstick Practice Green	144 - 147	Hitting Net	43
Distance Posts	94	Flagsticks	122 - 130	Hole Cups	135 - 139
Distance Signs	38	Flat Dimple Tee Marker	87	Hole Cutter Accessories	84 - 186
Dividers	28, 30, 31	Flat Top Ball Dispensers	57	Hole Cutter Board	187
Divot Container Teak	104	Floater	7	Hole Cutter Carrier	186
Divot Mate Container	104	Floor mount combination	172	Hole Cutter Guide	187
Divot Mix Containers	104, 105	Flo-Pro Inline Applicator	216	Hole Cutter Parts	179
Divot Pro Jr.	104	Folding Dewmaster	191	Hole Cutters	178 - 183
Divot Pro Teak	104	Foot Extraction Hole Cutter	178	Hole Flags	115-121
Double Barrel Paint Applicator	177	FootGolf Cup	142	Hole Painter	188, 189
Double Insert Mat Systems	16	FootGolf Cup cover	142	Hole Trimmer Scissors	187
Double Litter Bin	111	FootGolf Dimple Tee Marker	143	Hole Whitener	189
Drag Brush	192	FootGolf direction sign	143	Hole-In-White Paint	189
Dragmats	192, 193	FootGolf Flags	143	Hollow Tees	22
Drainblaster Cleaning Nozzles	216	FootGolf Tee marker	143	Hoppers	52
Dressing Tools	190 - 193	Fore Ever Marked Tee marker	89	Hose Cars	211
Driving Range Netting	42	Forky	229	Hose Clamp	212
Dual Ball Dispensers	59	Frames for banners	39	Hose Swivels	218
Duchell Nylon Stance Mat	14, 21	Frames for mats	12, 16	Hose Tap Adaptor	218
Duchell Shoe Brush	170	Friction Fit Tees	23	Hose Washer	212
Dura-Flex Signs	156			Hoses	210, 211
Dutch Tee Sign	75	G		Hybrid ST2000	138
Du-Whipper	190	Garden Fork	176		
E		Giftbag	229	I	
EasyMark System II	37	Gold Rake	162	Igloo Cooler	112
EasyReach Key	217	Golf Lockers	64 - 66	Imax Ball Pickers	46
Economy Rake	167	Golf Shoe Valet	173	Imax Basket	24
Economy Tee Towels	113	Golf Swing	34	Imax Classic Airlastic Frame	13
Edging Knife	176	Golf Target	35	Imax Classic Airlastic Range Mat	13
E-key Holder	231	Golfgifts	229 - 231	Imax Inserts	21
E-Keys	62, 63	Grass Stance Mats	17	Imax Matkeeper	12
Electric Shoe Cleaners	173	Green & White Directional Markers	101	Imax mirror	18
Elevators	55	Green Line Fairway Signs	157	Imax Ultima insert	17
Embroidered Flags	120, 148	Green Speed Meter	196	Impact Sprinklers	219
Embroidered Junior Flags	145, 148	Greenfee giftbag	229	Indicator Longest & Neary	v92, 93
End Caps	101	Greenfee gifts	229	Indoor Grass	18 - 22
Ensembles	78, 79	Greenkeeper Ball Mark Repair Tool	197	Information Signs	70 - 75, 155 - 159
Epic Ball Pickers	47	Greens Bullit	203	INKA Clock	154
Epic Manual Ball Pickers	50	Greensaver	197	Inlays	17
E-Range	62, 63	Greentec Light Mats	8	Inline Applicator	216
Ernest Sport	29 - 33	Greentec Pro Mats	8	Interactive Bay Divider	30, 31
ES12, ES14, ES15, ES20/20	29 - 33	Greentec Putting Turf	21	Interactivity	40
Euro Mechanisms	60	Greentec Smartline Mats	10	Iroko Maintenance	70
Ever White Sleeves	136	Grips	166	Irrigation Accessories	210 - 223
Ever-White Cups	136	Grommets	132, 133	Irrigation Head Trimmers	200, 201
Executive Putting Green Markers	146	Ground Mounting Spikes	86	Irrigation Maintenance Tool	200, 201
		Gulps	221	Irrigation Portable	219, 220

- PRODUCT INDEX -

J		
Jost Bunker Rake	160	
Jumbo Multiflex Ball Picker	48	
Junior Bench	151	
Junior Console	83	
Junior Flags	145, 148, 149	
Junior Flagsticks	144, 146	
K		
Key Chain	230	
Kirby Marker System	96	
Knife	176	
Kooler Aid Water Station	112	
L		
Laminated Directional Signs	158	
Laminated Fairway Distance Markers	96	
Landscape Rake	199	
Launch Monitors	29, 33	
LED Lighting	44, 45	
Letter Opener	230	
Level spreader	194	
Levelawn	194	
Leven Tee Sign	74	
Lever Action Hole Cutter	178	
Lids Litter Bins	109	
Lighting	44, 45	
Link Chain	99	
Liquid Detergent	81	
LiquidPro Applicator	215	
Litter Bins	78, 79, 83, 106 - 111	
Litter Caddies	110	
Lockers	64 - 66	
Logo Flags	120, 121, 148, 149	
Logo Gifts	229 - 231	
Logo Items	229 - 231	
Logo Tee Markers	88, 89	
Longest Indicators	92, 93	
Low Stand Only	109	
M		
Magnum Hole Cutter	182	
Magnum Hose Nozzle	213	
Magnum Monster Broom	193	
Maintenance	70	
Maintenance Bunker Rake	199	
Maintenance Tools	176	
Mallet	183	
Manual Ball Collectors	51	
Manual Ball Pickers	50	
Map	72 - 75	
Markers Longest & Neary	92, 93	
Marking Paint	177	
Master Ball Washer	77	
Master Ensembles	78	
Mat frames	12	
Matkeeper	12	
Mats	8 - 21	
Mats Custom Shape	10	
Mats for Dressing	192, 193	
Maxi Multiflex Ball Picker	48	
Measuring System	131	
Medalist Ball Washer	82	
Memo Holder	231	
Memo Pad Holder	231	
Mender	212	
Message Holder	92, 159	
Message Kit	153	
Metal Distance Plates	97, 98	
MGI trolleys	227	
Midi Ball Pickers	48	
Mirror	18	
Monster Broom	193	
Mounting Bracket Club Washer	86	
Mounting Kit Club Washer	86	
Mounting Pipes	81, 108	
Mounting Spikes Club Washer	86	
Mow Over Sign	73	
Multiflex Ball Picker	48	
Multilevel Practice mat	10	
Multimax Adjustable Nozzle	214	
N		
Nayax Card System	63	
Neary Indicators	92, 93	
Net for Safety	205	
Netting	42	
Nozzles	213 - 216	
Numbered Flags	116, 118	
Numbered Junior Flags	145, 148	
Numbered Practice Green Pennant	147	
Nylon Netting	42	
Nylon Range Banners	39	
O		
On The Tee Accessories	152	
Out-Of-Bounds Markers	100	
P		
Paddington Tee Sign	75	
Paint	81, 177, 188, 189	
Paint Applicator	177	
Paint for Holes	188, 189	
Paper Cups	112	
Par 3 distance Sign	73	
Par Aide Ball Washers	76-80	
Pattisson Accorn Nut	123	
Pattisson Aluminium Hole cup	135	
Pattisson Aluminium Hole Cup	135	
Pattisson Aluminium Pro Hole cup	135	
Pattisson Brushmaster Electric Shoe Cleaner	173	
Pattisson Checkered Flags	119	
Pattisson Cotton Tee Towels	113	
Pattisson Dimple Tee Marker Flat	87	
Pattisson Ferrule	123	
Pattisson Flags	115-121	
Pattisson Golf Shoe Valet	173	
Pattisson Heavy Duty Hole Cutter	183	
Pattisson Hexagon Turf Doctor	204	
Pattisson Junior flagstick	144	
Pattisson Numbered Flags	116	
Pattisson plastic hole cup	135	
Pattisson Pot Painter	189	
Pattisson Premier Hole Cutter	183	
Pattisson Pro Alu Base	144	
Pattisson Pro Rake	161	
Pattisson Quick Locking Pin	123	
Pattisson Regular Flagstick	122	
Pattisson sleeves for cups	135	
Pattisson Teakwood Bay Dividers	28	
Pattisson Tour Rake	161	
Pattisson Tournament Flagstick	123	
Payment Systems	60 - 63	
PelletPro Applicator	215	
Pencil	229	
Pennant Set	147	
Perennial Tournament Flagstick	130	
Perimeter Netting	42	
Personalised Dimple T-Markers	88	
Picker Spare Parts	49	
Pickers	46 - 49	
Pine Tee Markers	87	
Pinsite Reflector	131	
Pipes	81, 108	
Pitch Fork	230	
Pitch repairer	229	
Placement Flags	133	
Placement Markers	132	
Plain Dimple T-Markers	88	
Plain Flags	115, 117	
Plain Junior Flags	145, 148	
Plastic Arrows	72	
Plastic Ball Tray for Ball Stackers	25	
Plastic Baskets	24	
Plastic Broken Tee Caddies	91	
Plastic Klikka Tube	51	
Plastic Cups	135, 137, 138	
Plastic Hole Cup	135	
Plastic Link Chain	99	
Plastic Range Banner	38	
Plastic Tee Marker	89	
Please Repair Ball Marks	132, 133	
Plug Pusher	198	
Portable Irrigation	219, 220	
Portable Spike Brush Stand	171	
Post for Signs	72	
Pot Painter	189	
Powerhead	200	
Practice Green Cups	135, 137, 138	
Practice Green Markers	144 - 147	
Practice Green Pennant Set	147	
Practice Green Plastic Cup	136, 137, 139	
Practice Green System	140	
Practice Mat	10	
Practice Range Signs	38	
Precision Nozzle	215	
Premier Ball Washer	82	
Premier Hole Cutter	183	
Premier Line Marker Paint	177	
Pre-Soaker	55	
Press Tees	22	
Pride tees	228	
Print On White Junior Flags	149	
Printed Flags	120, 121, 149	
Prism Flagstick	127	
Pro Alu base	144	
Pro hole cup	135	
Pro II Hole Cutter	182	
Pro Net	43	
Pro Rake	161	
Pro Return Net	43	
Pro shop	224	
Promotional Banners	39	
Promotional Banners XL	39	
Promotional Bay Dividers	28, 30, 31	
Promotional Gifts	229 - 231	
Proplex Distance marker	94	
Protect Handle	166	
Proximity Markers	92, 93	
Proximity Markers Aluminium	92	
Proximity Markers Plastic	92	
Putting Cups	135 - 139	
Putting Cups Accessories	141	
Putting Green Markers	144 - 147	
Putting Turf	21	
Putt-saver Tournament Flagstick	129	

- PRODUCT INDEX -

PVC Distance Markers	94	Rolling Ball Picker	51	Spike Brushes	170 - 173
PVC Hazard Markers	100	Rope	99	Splice Kit	217
Pyramid Ball Stackers	25	Rope Stakes	102, 103	Spreader	194
Q		Round Basket	24	Sprinkler Distance Markers	97, 98
Quattro Excell Mats	9	Round Club washer	85	Sprinkler Nozzles	223
Quick Connectors	212	Round Mouth Shovel	176	Sprinkler Tools	217
Quick Coupling Keys	218	Round Mow Over Sign	73	Sprinkler Trimmers	200
Quick Coupling Valves	218	Royaline Flagstick	128	Sprinklers	219
Quick Fill Ball Mark Eraser	203	Rubber Frames	12,14	Square Basket	24
Quick Locking Pin	123, 125, 129	Rubber Mallet	183	Square Pattern Boot Wiper	170
R		Rubber Square Safety Tiles	19	Square Safety Tiles	19
Rainpro Shower Nozzles	216	Rubber Tees	22, 23	Square Target	37
Rake Bearer	160	Rubber Tiles	19	Square Tee Markers	87
Rake Handles	160-169	Rubber Wings	14	Squeegee	198
Rake Heads	160-169	Ruler	230	ST2000 Cups	138
Rakes	160-169,199	S		Stackers	25
Range Ball Storage Box	152	Safety Net	205	Stainless steel Contest indicator	92, 159
Range Balls	6, 7	Safety Tiles	19	Stainless steel Logest Drive	92, 159
Range Banner Frames	v39	Scissors	187	Stainless steel Message Holder	92, 159
Range Banners	38, 39	Scoop	50	Stainless Steel Shoe Cleaner	173
Range Dividers	28, 30, 31	Score Cards	69	Stand for Divot Container	105
Range Flags	37	Screening Rake	199	Standard Golf Ball Washer	82 - 84
Range Flooring	18, 19	Screw-Fit Standard Rake	160	Stands	26
Range Grass	19	Scrusher	171	Stands for Baskets	25
Range Mate Clubwasher	85	Seed & Soil Caddy	105	Stanmore Telescopic Turfswitch	191
Range Netting	42	Semaphore Flags	119	Steel Bag Stand	26
Range Servant Ball Washer BT1000	53	Sharpener for Hole Cutter	187	Steel Bay Dividers	28
Range Servant Ball Washer BT1300	52	Shear	176	Steel Broken Tee Caddies	91
Range Servant Ball Washer BT1950	52	Shells for Hole Cutters	1 78 - 183	Steel Klikka Tube	51
Range Servant Ball Washers	52	Shoe Brush	170 - 173	Steel Distance Markers	95
Range Servant Dispensers	57 - 59	Shoe Cleaners	170 - 173	Steel Rope Stakes	102
Range Servant Inline Ball Picker	48	Shoe Valet	173	Sticker Sets for Cast Aluminium Markers	145
Range Servant Manual Ball Pickers	50	Short distance balls	7	Stickers for Dimple T-Markers	88
Range Signs	38	Shovel	176	Stimp Meter	196
Range Tape	27	Shower Nozzles	216	Stone Tiles	19
Range Targets	35 - 37	Side Brush for Shoe Cleaners	172	Stop Stud	125
Ratcheting Tool	201	Side Netting	42	Storage Box	152
Reader E-range	62	Sign Pattisson	157	Superkey XL	217
Recycled plastic Bag stand	26	Sign Post	159	Sure Putt Practice Green System	140
Recycled Plastic Broken Tee Box	90	Signage	70 - 75, 155 - 159	Sweeper Nozzle	214
Recycled plastic Club washer	85	Signs	70 - 75, 155 - 159	Sweet roll rail system	196
Recycled Plastic Double litter bin	111	Signs for Distances	38	Swing Studio	32
Recycled Plastic Range Banner	38	Simulation	32	Syringe Ultra Gulp	221
Recycled Plastic Round Hazard Markers	100	Single Insert Mat systems	16	T	
Recycled Plastic Square Hazard Markers	100	Single Pipe Mount Spike Brush	172	Tablets	81
Recycled Rubber Cup Covers	141	Sleeves	135	Tap for Hose	218
Recycled Rubber Tee Distance Markers	95	Slot Machine	200	Tape	27
Recycles Rubber Ball Tray	14	Smartline Mats	10	Tape Measure	231
Reflector	131	Soaker	55	Target Greens	41
Regulation Flagsticks	122, 124	Sod Stripper	207	Target Pro XL	36
Rental Trolley	114	Soft spikes	228	Target Systems	35 - 37
Replacement Blade	178 - 183	Soil Probe	207	Targets	35 - 37
Replacement Brushes	85, 170 - 172	Soil Testers	207	Teaching mats	11
Replacement Parts for Hole Cutter	179	Soko Cross Tees	23	Teak Arrows	72
Replacement Parts for Turf Mender	179	Soko Tees	22	Teak Bag Stand	26
Replacement Shells	182	Solid Metal Base	144, 145	Teak Benches	151
Resin Cup Covers	141	Sonic target	35	Teak Chain Stake	103
Return Net	43	Spade	176	Teak Distance Posts	94
Riji Cup	139	Spare Parts Epic Picker	49	Teak Divot Container	104
Ring for Holes	189	Spare Parts Imax Picker	49	Teak Hazard Markers	100
Rod for Dewmaster	191	Spare Parts Range Servant Picker	49	Teak Maintenance	70
Roll rail system	196	Special Event Adapter	202	Teak Rope Stake	103
Roller Pro Spinkler	219	Special Event Cups	140	Teak Serie Signs	155
Roller Squeegee	198	Special Event Hole Cutter	202	Teak Serie Square Litter Bin	106
		Specialty Rakes	199	Teak Tee Marker Square	87
		Specialty Tools	198	Teak Tee Signs	75
		Speed Meter Greens	196	Teak Wooden Basket	24
		Spherical Plastic Tee Marker	89		

- PRODUCT INDEX -

Teakwood Bay Dividers	28	Turf Mats	8-21
Technobross Ultrasonic Club cleaner	85	Turfjector	206
Technobrush Stainless Steel		Turfmaster Hole Cutter	183
Shoe Cleaner	173	Turfspy Detection Glasses	222
Technowood Bag Stand	26	Tweed Tee Sign	74
Technowood Bay Divider	28	Twister Ball Washer 1	54
Technowood Benches	150	Twister Ball Washer 4	54
Technowood Clock / Message kit	153		
Technowood Finger Post	72	U	
Technowood Litter Bin	110	Ultima Dispensing System	57 - 59
Technowood litter bin 4 Combo	111	Ultima insert	17
Technowood Litter Bin Triple	111	Ultima Mats	17
Technowood Maintenance	70	Ultra Gulp	221
Technowood Tee Sign	74	Ultra Max Hose	210
Tee Grass	15	Ultra Throttle	213
Tee Grass 30	15	Ultra Turbo Shift	213
Tee Marker Square	87	UltraMax Gulp Plus	221
Tee Markers	87 - 89	UltraMax Nozzle	213
Tee Sign Paddington	75	Ultrasonic club cleaner	85
Tee Signs	74, 75	Unpluggger	51
Tee Target	35		
Tee Towels	113	V	
Tee Turf	11, 15	Versalid	217
Tee Turf Insert	17	Vink Ball Washer	53
Tee Turf Mats	11	Vinyl Guard Flagstick	122, 123, 126
Tee Turf On Roll	15		
Tees	22, 23	W	
Telescopic Turfswitch	191	Walking Grass	19
Terms and Conditions	230	Wall Clock	153
Testing soil tools	207	Wall Mount Bracket	109
The Dutch Tee Sign	75	Walmer Bench	151
The Golf Target	35	Water Cooler	112
The Medalist Ball Washer	82	Water Pro	112
The Premier Ball Washer	82	Water Pro Complete	112
Tiles	19	Water Pro Jr.	112
Token Mechanism	60	Water Removal Pumps	221
Tokens	60	Watering Accessories	210 - 223
Top Dressing	190-194	Watering Stakes	219
Top Dressing Tools	190 - 193	Weed Wand	196
Top Knob	144	Wellstroke Mats	226
Touch-Up Paint	81	Whipping Poles	190
Tour Pro Rake	165	Wings for Balls	14
Tour Rake	161	Winter Cup	140
Tour Smooth II Rake	168	Wire Baskets	24
Tour-Lite Rake	167	Wooden Basket	24
Tournament Flagsticks	123, 125, 126, 127, 129, 130	Wooden directional Signs	156
Towels	113	Wooden Flagstick	130
Tracker	220	Wooden Practice Green Marker	146
Traditional Series Ball Washers	82		
Traffic Control	99, 101-103	X	
Training system	34	Xafax payment system	61
Transportation Systems	55, 56	XL Hoppers	v52
Trash Mate Trash Double Unit	108		
Trash Mate Trash Single Unit	108	Z	
Trash Mates	107, 111	Z-box	174
Trash Pro 10	110	Zelup Cleaning system	174
Trash Pro 20	110	Zelup kit	174
Trays for Balls	14	Z-station	174
Treaded Spade	176		
Trico Flex Hose	211		
Trifold Cotton Tee Towels	113		
Trimming Scissors	187		
Triple Litter Bin	111		
Trolleys	114, 227		
Tummy Steel Markers	95		
Turbo Trim Ratcherting tool	201		
Turf Doctor	204		
Turf Mats	8 - 11		

- NOTES -

A series of horizontal dotted lines for writing notes.

- NOTES -

A series of horizontal dashed lines for writing notes.

NOTES

DISTRIBUTED BY:



SIBE Golf AG
Altstetterstrasse 279
8047 Zürich

044 400 44 95
golf@sibeag.ch
www.sibeag.ch



DUCHELL BV | STERRENBERGWEG 40 | 3769 BT SOESTERBERG | THE NETHERLANDS
T +31(0)346 350 550 | E INFO@DUCHELL.COM

WWW.DUCHELL.COM